



streetlights & floodlights



Beghelli



Tereza 50-01 128



SunLED 51-91 130



Santo 0146 132



Santo 0147 133



Krono 5611-261 134



Euro 5611-270 135



Marco 5611-280 136

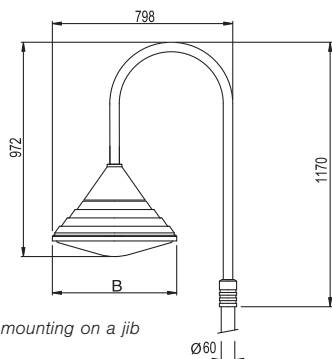

top mounting on a jib

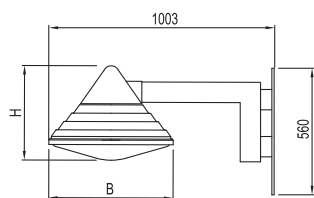

side mounting on a wall

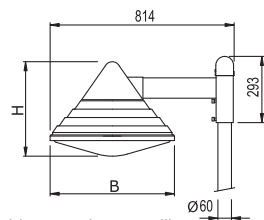

side mounting on a jib

Material:

- body: the gearbox and the lamp-body are plastic moldings carrying the lamp holder; the gearbox is covered by a plastic lid
- color: black RAL 9005
- reflector: a steel sheet finished by powder technology varnishing
- cover: polycarbonate (transparent or opal)

Degree of protection: IP 23/54

Rated voltage: 230V/50Hz

Control gear: standard ballast with parallel compensation

Mounting: on a jib - side mounting (50-01), on a jib - top mounting (50-03)

Accessories: jibs (must be ordered separately - see Jibs of the series 50)

Application: pedestrian precincts, quietened down areas, parks, side-walk ways

Code	Power	Diffuser	Lamp	Cap	BxH (mm)	Kg
50-016/107/BY	1x70W	transparent	h.p. sodium lamp	E27	550x422	7,5
50-016/107/BZ	1x70W	opal	h.p. sodium lamp	E27	550x422	7,5
50-016/110/BY	1x100W	transparent	h.p. sodium lamp	E27	550x422	7,8
50-016/110/BZ	1x100W	opal	h.p. sodium lamp	E27	550x422	7,8
50-017/110/BY	1x100W	transparent	metal hal. lamp	E27	550x422	7,8
50-017/110/BZ	1x100W	opal	metal hal. lamp	E27	550x422	7,8
50-017/115/BY	1x150W	transparent	metal hal. lamp	E27	550x422	8,0
50-017/115/BZ	1x150W	opal	metal hal. lamp	E27	550x422	8,0
50-036/107/BY	1x70W	transparent	h.p. sodium lamp	E27	550x422	7,5
50-036/107/BZ	1x70W	opal	h.p. sodium lamp	E27	550x422	7,5
50-036/110/BY	1x100W	transparent	h.p. sodium lamp	E27	550x422	7,8
50-036/110/BZ	1x100W	opal	h.p. sodium lamp	E27	550x422	7,8
50-037/110/BY	1x100W	transparent	metal hal. lamp	E27	550x422	7,8
50-037/110/BZ	1x100W	opal	metal hal. lamp	E27	550x422	7,8
50-037/115/BY	1x150W	transparent	metal hal. lamp	E27	550x422	8,0
50-037/115/BZ	1x150W	opal	metal hal. lamp	E27	550x422	8,0

Jibs of the series 50 | tereza

straight jib (on wall or lamp-post; \varnothing 60mm)

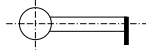

99-201

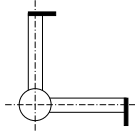

99-202

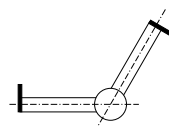

99-203

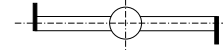

99-204

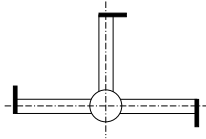

99-205

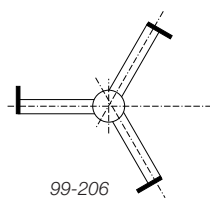

99-206

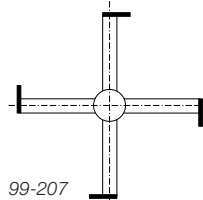

99-207

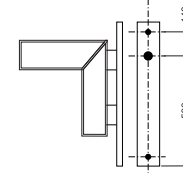

99-216

arched jib (on wall or lamp-post \varnothing 60mm)

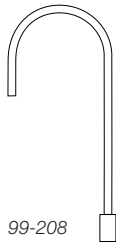

99-208

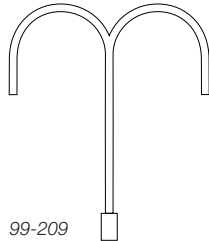

99-209

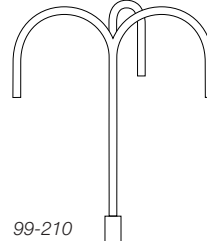

99-210

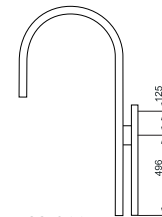

99-211

angular jib (on wall or lamp-post \varnothing 60mm)

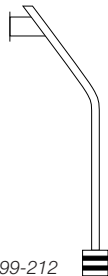

99-212

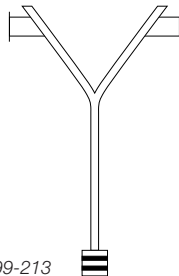

99-213

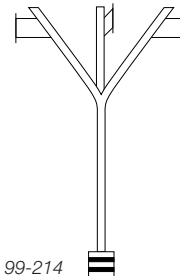

99-214

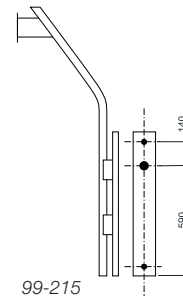

99-215

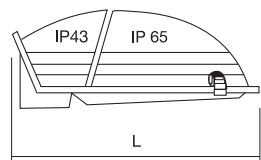
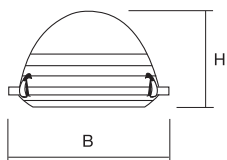
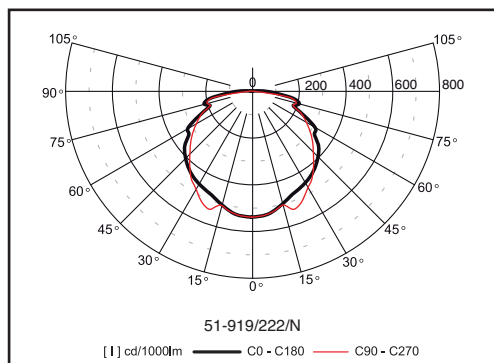

Material:

- body: the cover box is made of UV-stabilized polypropylene (PP) reinforced by glass fibres, the gear box is made of UV stabilized polycarbonate (PC) reinforced by glass fibres
- color: grey
- reflector: polished aluminium sheet
- diffuser: hardened glass

Degree of protection: optical part IP 65/gear box IP 43

Rated voltage: 230V AC1 +/-10%, 50Hz

Mounting: universal mounting on stand or jib (Ø42~60mm)

Accessories: (must be ordered separately)

99-129 – programmer of timer (only for version with timer 51-999)

Application: traffics and subsidiary roads, parking sites, industrial areas, roundabouts

Luminaire is equipped with LED's 4000K.

Lifetime of LED 100 000 hours. Colour rendering index Ra > 80.

Version 51-999 is supplied with complementary module for timing (possibility of decreasing power, for example from 23:00 to 4:00 hours).

Code	Power	Number LEDs	LED color temp.	Lumen per watt	LxBxH (mm)	Kg
standard version						
51-919/222/N	46/16W	22	4000K	107lm/W	500x310x190	3,2
51-919/112/N	28/11W	11	4000K	107lm/W	500x310x190	3,2
version with timer						
51-999/222/N	46/16W	22	4000K	107lm/W	500x310x190	3,3
51-999/112/N	28/11W	11	4000K	107lm/W	500x310x190	3,3



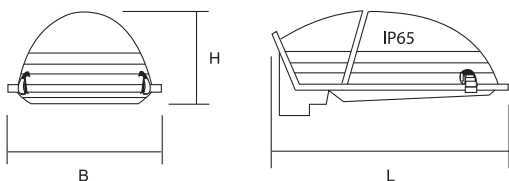

Material:

- body: the cover box is made of UV stabilized polypropylene (PP) reinforced by glass fibres, the gear box is made of UV stabilized polycarbonate (PC) reinforced by glass fibres
- color: gray
- reflector: polished aluminium sheet
- diffuser: hardened glass

Degree of protection: optical part IP 65/gear box IP 43

Rated voltage: 230V/50Hz

Control gear: standard ballast with parallel compensation

Mounting: universal mounting on stand or jib (Ø42~60mm)

Application: traffics and subsidiary roads, parking sites, industrial areas, roundabouts

Lamp is not supplied with the luminaire.

Code	Power	Lamp	Cap	LxBxH (mm)	Kg
0146-HM1050FGC	1x50W	mercury lamp	E27	500x310x190	4,7
0146-HM1080FGC	1x80W	mercury lamp	E27	500x310x190	4,7
0146-HM1125FGC	1x125W	mercury lamp .	E27	500x310x190	4,7
0146-HS1050FGC	1x50W	h.p. sodium/ metal hal. lamp	E27	500x310x190	4,7
0146-HS1070FGC	1x70W	h.p. sodium/ metal hal. lamp	E27	500x310x190	4,7

Streetlights

0147 | santo



Material:

- body: the cover box is made of UV stabilized polypropylene (PP) reinforced by glass fibres, the gear box is made of UV stabilized polycarbonate (PC) reinforced by glass fibres
- color: gray
- reflector: polished aluminium sheet
- diffuser: hardened glass

Degree of protection: optical part IP 65/gear box IP 43

Rated voltage: 230V/50Hz

Control gear: standard ballast with parallel compensation

Mounting: universal mounting on stand or jib (Ø42~60mm)

Application: traffics and subsidiary roads, parking sites, industrial areas, roundabouts

Lamp is not supplied with the luminaire.

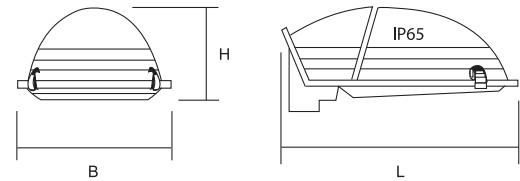

Code	Power	Lamp	Cap	LxBxH (mm)	Kg
0147-HM1250FGC	1x250W	mercury lamp	E40	620x380x220	6,3
0147-HS1100FGC	1x100W	h.p. sodium/ metal hal. lamp	E40	620x380x220	5,8
0147-HS1150FGC	1x150W	h.p. sodium/ metal hal. lamp	E40	620x380x220	5,8
0147-HS1250FGC	1x250W	h.p. sodium/ metal hal. lamp	E40	620x380x220	6,3

krono | 5611-261

Floodlights

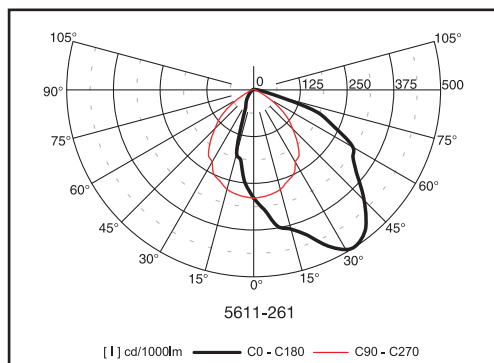

Gear box
5611-292
(12,8kg)



Gear box
5611-293
(12,8kg)



Material:

- body: made of die-cast aluminium
- color: gray
- reflector: asymmetric

Degree of protection: IP 65

Rated voltage: 230V/50Hz

Control gear: standard ballast with parallel compensation

Mounting: on a revolving bracket

Accessories: (must be ordered separately)

5611-292 – gear box for lamps HQI-T and HPI-T 1000W

5611-293 – gear box for lamps NAV-T and SON-T 1000W

Application: large edifices, sport stadiums, historical buildings

Lamp is not supplied with the luminaire.

Standard order quantity is 40pcs.

The distance of gearbox with ignitor from luminaire must not exceed 20m.

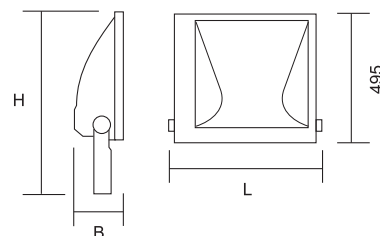

Code	Power	Power supply	Cap	LxBxH (mm)	Kg
5611-261	1x1000W	230V	E40	440x210x690	16,5

Floodlights



Material:

- body: made of die-cast aluminium
- color: black
- reflector: symmetric

Degree of protection: IP 65

Rated voltage: 230V/50Hz

Control gear: standard ballast with parallel compensation

Mounting: on a revolving bracket

Accessories: (must be ordered separately)

5611-292 – gear box for lamps HQI-T and HPI-T 1000W

5611-293 – gear box for lamps NAV-T and SON-T 1000W

Application: large edifices, sport stadiums, historical buildings

Lamp is not supplied with the luminaire.

Standard order quantity is 40pcs.

The distance of gearbox with ignitor from luminaire must not exceed 20m.

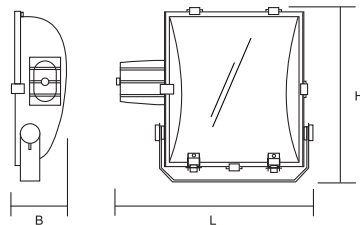
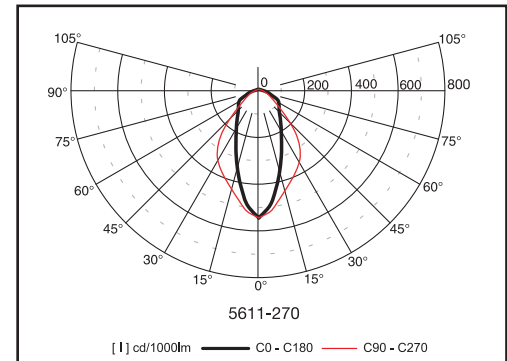

Gear box
5611-292
(12,8kg)



Gear box
5611-293
(12,8kg)



Code	Power	Power supply	Cap	LxBxH (mm)	Kg
5611-270	1x1000W	230V	E40	600x162x525	8,5

marco | 5611-280

Floodlights

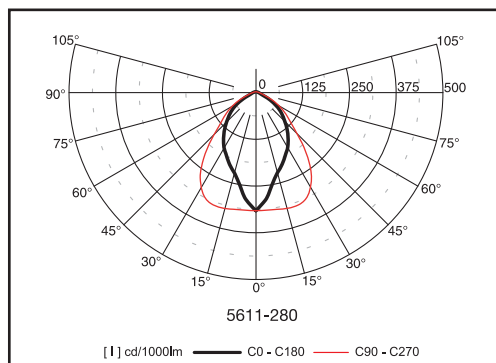
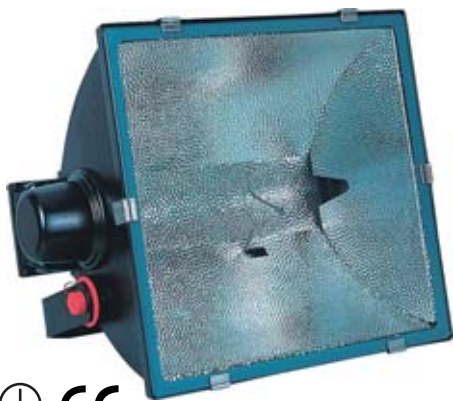

Material:

- body: made of die-cast aluminium
- color: black
- reflector: symmetric

Degree of protection: IP 65

Rated voltage: 380V/50Hz

Control gear: standard ballast with parallel compensation

Mounting: on a revolving bracket

Accessories: (must be ordered separately)

5611-296 - gear box for lamps HQI-T and HPI-T 2000W

Application: large edifices, sport stadiums, historical buildings

Lamp is not supplied with the luminaire.
Standard order quantity is 27pcs.

Gear box
5611-296
(15,8kg)

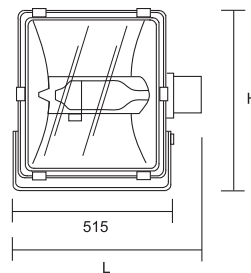
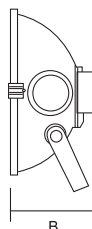

Position of ignitor

Code	Power	Power supply	Cap	LxBxH (mm)	Kg
5611-280	1x2000W	380V	E40	590x295x520	13,5



Index and Business terms & conditions

Code	page	Code	page	Code	page	Code	page
3616PR	115	14236TE	113	03-013/214/CB+2	14	03-013/258/EB+2	14
3617PR	115	14236TR	112	03-013/214/CC+1	14	03-013/258/EC+1	14
3618PR	115	14258	112	03-013/214/CC+2	14	03-013/258/EC+2	14
3619PR	115	14258TE	113	03-013/218/CB+1	14	03-013/258/ED+1	14
3619RE	115	14258TR	112	03-013/218/CB+2	14	03-013/258/ED+2	14
3620PR	115	14700	55	03-013/218/CC+1	14	03-013/258/EJ+1	14
3621PR	115	14701	55	03-013/218/CC+2	14	03-013/258/EJ+2	14
3621RE	115	14702	55	03-013/218/CD+1	14	03-023/214/CB	15
3715	115	14703	55	03-013/218/CD+2	14	03-023/214/CC	15
3716	115	14708	55	03-013/218/CJ+1	14	03-023/218/CB	15
3718	115	14709	55	03-013/218/CJ+2	14	03-023/218/CC	15
3719	115	14710	55	03-013/218/EB+1	14	03-023/218/CD	15
8010	115	14711	55	03-013/218/EB+2	14	03-023/218/CJ	15
8012	115	14723	54	03-013/218/EC+1	14	03-023/218/EB	15
13393	125	14724	54	03-013/218/EC+2	14	03-023/218/EC	15
13394	125	14725	54	03-013/218/ED+1	14	03-023/218/ED	15
13395	125	14726	54	03-013/218/ED+2	14	03-023/218/EJ	15
13396	125	14740	54	03-013/218/EJ+1	14	03-023/228/CB	15
13397	125	14741	54	03-013/218/EJ+2	14	03-023/228/CC	15
13402	125	14742	54	03-013/228/CB+1	14	03-023/235/CB	15
13403	125	14750	54	03-013/228/CB+2	14	03-023/235/CC	15
13404	125	14751	54	03-013/228/CC+1	14	03-023/236/CB	15
13405	125	14770	54	03-013/228/CC+2	14	03-023/236/CC	15
14100	109	14771	54	03-013/235/CB+1	14	03-023/236/CD	15
14101	109	14772	54	03-013/235/CB+2	14	03-023/236/CJ	15
14102	109	14773	54	03-013/235/CC+1	14	03-023/236/EB	15
14103	108	0146-HM1050FGC	132	03-013/235/CC+2	14	03-023/236/EC	15
14104	108	0146-HM1080FGC	132	03-013/236/CB+1	14	03-023/236/ED	15
14105	108	0146-HM1125FGC	132	03-013/236/CB+2	14	03-023/236/EJ	15
14106	108	0146-HS1050FGC	132	03-013/236/CC+1	14	03-023/258/CB	15
14107	108	0146-HS1070FGC	132	03-013/236/CC+2	14	03-023/258/CC	15
14108	108	0147-HM1250FGC	133	03-013/236/CD+1	14	03-023/258/CD	15
14110	108	0147-HS1100FGC	133	03-013/236/CD+2	14	03-023/258/CJ	15
14111	108	0147-HS1150FGC	133	03-013/236/CJ+1	14	03-023/258/EB	15
14112	108	0147-HS1250FGC	133	03-013/236/CJ+2	14	03-023/258/EC	15
14113	108	02-013/114/C	12	03-013/236/EB+1	14	03-023/258/ED	15
14118	112	02-013/128/C	12	03-013/236/EB+2	14	03-023/258/EJ	15
14118TR	112	02-013/135/C	12	03-013/236/EC+1	14	03-033/214/CB	16
14120	108, 109	02-023/114/C	12	03-013/236/EC+2	14	03-033/214/CC	16
14121	108, 109	02-023/128/C	12	03-013/236/ED+1	14	03-033/218/CB	16
14122	108	02-023/135/C	12	03-013/236/ED+2	14	03-033/218/CC	16
14123	108	02-033/214/C	13	03-013/236/EJ+1	14	03-033/218/CD	16
14124	108	02-033/228/C	13	03-013/236/EJ+2	14	03-033/218/CJ	16
14136	112	02-033/235/C	13	03-013/258/CB+1	14	03-033/218/EB	16
14136TE	113	02-043/214/C	13	03-013/258/CB+2	14	03-033/218/EC	16
14136TR	112	02-043/228/C	13	03-013/258/CC+1	14	03-033/218/ED	16
14158	112	02-043/235/C	13	03-013/258/CC+2	14	03-033/218/EJ	16
14158TE	113	03-000/218	16	03-013/258/CD+1	14	03-033/228/CB	16
14158TR	112	03-000/236	16	03-013/258/CD+2	14	03-033/228/CC	16
14218	112	03-000/258	16	03-013/258/CJ+1	14	03-033/235/CB	16
14218TR	112	03-003/218	16	03-013/258/CJ+2	14	03-033/235/CC	16
14236	112	03-013/214/CB+1	14	03-013/258/EB+1	14	03-033/236/CB	16

Code	page	Code	page	Code	page	Code	page
03-033/236/CC	16	04-013/158/EZ	17	07-043/154/CC	21	09-043/235/CJ	22
03-033/236/CD	16	05-003/128/C	18	07-043/180/CB	21	09-063/228/CB	23
03-033/236/CJ	16	05-003/135/C	18	07-043/180/CC	21	09-063/228/CC	23
03-033/236/EB	16	05-003/136/C	18	07-043/228/CB	21	09-063/228/CD	23
03-033/236/EC	16	05-003/136/E	18	07-043/228/CC	21	09-063/228/CJ	23
03-033/236/ED	16	05-003/158/C	18	07-043/235/CB	21	09-063/235/CB	23
03-033/236/EJ	16	05-003/158/E	18	07-043/235/CC	21	09-063/235/CC	23
03-033/258/CB	16	05-003/228/C	18	07-043/249/CB	21	09-063/235/CD	23
03-033/258/CC	16	05-003/235/C	18	07-043/249/CC	21	09-063/235/CJ	23
03-033/258/CD	16	05-003/236/C	18	07-043/254/CB	21	11-000/118	35
03-033/258/CJ	16	05-003/236/E	18	07-043/254/CC	21	11-000/136	35
03-033/258/EB	16	05-003/258/C	18	07-043/280/CB	21	11-000/158	35
03-033/258/EC	16	05-003/258/E	18	07-043/280/CC	21	11-000/218	35
03-033/258/ED	16	05-013/128/CB	19	09-013/128/CB	22	11-000/236	35
03-033/258/EJ	16	05-013/128/CC	19	09-013/128/CC	22	11-000/258	35
03-100/218	16	05-013/135/CB	19	09-013/128/CD	22	11-003/118	35
03-103/218	16	05-013/135/CC	19	09-013/128/CJ	22	11-003/218	35
04-013/114/CB	17	05-013/136/CB	19	09-013/135/CB	22	11-013/118/CA	24
04-013/114/CC	17	05-013/136/CC	19	09-013/135/CC	22	11-013/118/CB	24
04-013/114/CP	17	05-013/136/EB	19	09-013/135/CD	22	11-013/118/CC	24
04-013/114/CZ	17	05-013/136/EC	19	09-013/135/CJ	22	11-013/118/CD	24
04-013/118/CB	17	05-013/158/CB	19	09-013/228/CB	22	11-013/118/CJ	24
04-013/118/CC	17	05-013/158/CC	19	09-013/228/CC	22	11-013/118/CX	24
04-013/118/CP	17	05-013/158/EB	19	09-013/228/CD	22	11-013/118/CZ	24
04-013/118/CZ	17	05-013/158/EC	19	09-013/228/CJ	22	11-013/118/EA	24
04-013/118/EB	17	05-013/228/CB	19	09-013/235/CB	22	11-013/118/EB	24
04-013/118/EC	17	05-013/228/CC	19	09-013/235/CC	22	11-013/118/EC	24
04-013/118/EP	17	05-013/235/CB	19	09-013/235/CD	22	11-013/118/ED	24
04-013/118/EZ	17	05-013/235/CC	19	09-013/235/CJ	22	11-013/118/EJ	24
04-013/128/CB	17	05-013/236/CB	19	09-033/128/CB	23	11-013/118/EX	24
04-013/128/CC	17	05-013/236/CC	19	09-033/128/CC	23	11-013/118/EZ	24
04-013/128/CP	17	05-013/236/EB	19	09-033/128/CD	23	11-013/136/CA	24
04-013/128/CZ	17	05-013/236/EC	19	09-033/128/CJ	23	11-013/136/CB	24
04-013/135/CB	17	05-013/258/CB	19	09-033/135/CB	23	11-013/136/CC	24
04-013/135/CC	17	05-013/258/CC	19	09-033/135/CC	23	11-013/136/CD	24
04-013/135/CP	17	05-013/258/EB	19	09-033/135/CD	23	11-013/136/CI	26
04-013/135/CZ	17	05-013/258/EC	19	09-033/135/CJ	23	11-013/136/CJ	24
04-013/136/CB	17	05-033/128/CB	20	09-033/228/CB	23	11-013/136/CX	24
04-013/136/CC	17	05-033/128/CC	20	09-033/228/CC	23	11-013/136/CZ	24
04-013/136/CP	17	05-033/135/CB	20	09-033/228/CD	23	11-013/136/EA	24
04-013/136/CZ	17	05-033/135/CC	20	09-033/228/CJ	23	11-013/136/EB	24
04-013/136/EB	17	05-033/228/CB	20	09-033/235/CB	23	11-013/136/EC	24
04-013/136/EC	17	05-033/228/CC	20	09-033/235/CC	23	11-013/136/ED	24
04-013/136/EP	17	05-033/235/CB	20	09-033/235/CD	23	11-013/136/EI	26
04-013/136/EZ	17	05-033/235/CC	20	09-033/235/CJ	23	11-013/136/EJ	24
04-013/158/CB	17	07-043/128/CB	21	09-043/228/CB	22	11-013/136/EX	24
04-013/158/CC	17	07-043/128/CC	21	09-043/228/CC	22	11-013/136/EZ	24
04-013/158/CP	17	07-043/135/CB	21	09-043/228/CD	22	11-013/158/CA	24
04-013/158/CZ	17	07-043/135/CC	21	09-043/228/CJ	22	11-013/158/CB	24
04-013/158/EB	17	07-043/149/CB	21	09-043/235/CB	22	11-013/158/CC	24
04-013/158/EC	17	07-043/149/CC	21	09-043/235/CC	22	11-013/158/CD	24
04-013/158/EP	17	07-043/154/CB	21	09-043/235/CD	22	11-013/158/CI	26

Index and Business terms & conditions

Code	page	Code	page	Code	page	Code	page
11-013/158/CJ	24	11-013/258/EZ	24	11-013/418/EC	24	11-014/336/EJ	25
11-013/158/CX	24	11-013/318/CA	24	11-013/418/ED	24	11-014/355/CB	25
11-013/158/CZ	24	11-013/318/CB	24	11-013/418/EJ	24	11-014/355/CC	25
11-013/158/EA	24	11-013/318/CC	24	11-013/418/EX	24	11-014/355/CD	25
11-013/158/EB	24	11-013/318/CD	24	11-013/418/EZ	24	11-014/355/CJ	25
11-013/158/EC	24	11-013/318/CJ	24	11-013/436/CA	24	11-023/118/CA	27
11-013/158/ED	24	11-013/318/CX	24	11-013/436/CB	24	11-023/118/CB	27
11-013/158/EI	26	11-013/318/CZ	24	11-013/436/CC	24	11-023/118/CC	27
11-013/158/EJ	24	11-013/318/EA	24	11-013/436/CD	24	11-023/118/CD	27
11-013/158/EX	24	11-013/318/EB	24	11-013/436/CJ	24	11-023/118/CJ	27
11-013/158/EZ	24	11-013/318/EC	24	11-013/436/CX	24	11-023/118/CX	27
11-013/218/CA	24	11-013/318/ED	24	11-013/436/CZ	24	11-023/118/EA	27
11-013/218/CB	24	11-013/318/EJ	24	11-013/436/EA	24	11-023/118/EB	27
11-013/218/CC	24	11-013/318/EX	24	11-013/436/EB	24	11-023/118/EC	27
11-013/218/CD	24	11-013/318/EZ	24	11-013/436/EC	24	11-023/118/ED	27
11-013/218/CJ	24	11-013/336/CA	24	11-013/436/ED	24	11-023/118/EJ	27
11-013/218/CX	24	11-013/336/CB	24	11-013/436/EJ	24	11-023/118/EX	27
11-013/218/CZ	24	11-013/336/CC	24	11-013/436/EX	24	11-023/136/CA	27
11-013/218/EA	24	11-013/336/CD	24	11-013/436/EZ	24	11-023/136/CB	27
11-013/218/EB	24	11-013/336/CJ	24	11-013/458/CA	24	11-023/136/CC	27
11-013/218/EC	24	11-013/336/CX	24	11-013/458/CB	24	11-023/136/CD	27
11-013/218/ED	24	11-013/336/CZ	24	11-013/458/CC	24	11-023/136/CI	26
11-013/218/EJ	24	11-013/336/EA	24	11-013/458/CD	24	11-023/136/CJ	27
11-013/218/EX	24	11-013/336/EB	24	11-013/458/CJ	24	11-023/136/CX	27
11-013/218/EZ	24	11-013/336/EC	24	11-013/458/CX	24	11-023/136/EA	27
11-013/236/CA	24	11-013/336/ED	24	11-013/458/CZ	24	11-023/136/EB	27
11-013/236/CB	24	11-013/336/EJ	24	11-013/458/EA	24	11-023/136/EC	27
11-013/236/CC	24	11-013/336/EX	24	11-013/458/EB	24	11-023/136/ED	27
11-013/236/CD	24	11-013/336/EZ	24	11-013/458/EC	24	11-023/136/EI	26
11-013/236/CJ	24	11-013/358/CA	24	11-013/458/ED	24	11-023/136/EJ	27
11-013/236/CX	24	11-013/358/CB	24	11-013/458/EJ	24	11-023/136/EX	27
11-013/236/CZ	24	11-013/358/CC	24	11-013/458/EX	24	11-023/158/CA	27
11-013/236/EA	24	11-013/358/CD	24	11-013/458/EZ	24	11-023/158/CB	27
11-013/236/EB	24	11-013/358/CJ	24	11-014/236/CB	25	11-023/158/CC	27
11-013/236/EC	24	11-013/358/CX	24	11-014/236/CC	25	11-023/158/CD	27
11-013/236/ED	24	11-013/358/CZ	24	11-014/236/CD	25	11-023/158/CI	26
11-013/236/EJ	24	11-013/358/EA	24	11-014/236/CJ	25	11-023/158/CJ	27
11-013/236/EX	24	11-013/358/EB	24	11-014/236/EB	25	11-023/158/CX	27
11-013/236/EZ	24	11-013/358/EC	24	11-014/236/EC	25	11-023/158/EA	27
11-013/258/CA	24	11-013/358/ED	24	11-014/236/ED	25	11-023/158/EB	27
11-013/258/CB	24	11-013/358/EJ	24	11-014/236/EJ	25	11-023/158/EC	27
11-013/258/CC	24	11-013/358/EX	24	11-014/255/CB	25	11-023/158/ED	27
11-013/258/CD	24	11-013/358/EZ	24	11-014/255/CC	25	11-023/158/EI	26
11-013/258/CJ	24	11-013/418/CA	24	11-014/255/CD	25	11-023/158/EJ	27
11-013/258/CX	24	11-013/418/CB	24	11-014/255/CJ	25	11-023/158/EX	27
11-013/258/CZ	24	11-013/418/CC	24	11-014/336/CB	25	11-023/218/CA	27
11-013/258/EA	24	11-013/418/CD	24	11-014/336/CC	25	11-023/218/CB	27
11-013/258/EB	24	11-013/418/CJ	24	11-014/336/CD	25	11-023/218/CC	27
11-013/258/EC	24	11-013/418/CX	24	11-014/336/CJ	25	11-023/218/CD	27
11-013/258/ED	24	11-013/418/CZ	24	11-014/336/EB	25	11-023/218/CJ	27
11-013/258/EJ	24	11-013/418/EA	24	11-014/336/EC	25	11-023/218/CX	27
11-013/258/EX	24	11-013/418/EB	24	11-014/336/ED	25	11-023/218/EA	27

Code	page	Code	page	Code	page	Code	page
11-023/218/EB	27	11-033/136/EX	28	11-103/218	35	12-013/336/CD	29
11-023/218/EC	27	11-033/158/CA	28	12-000/128	35	12-013/336/CJ	29
11-023/218/ED	27	11-033/158/CB	28	12-000/136	35	12-013/336/EA	29
11-023/218/EJ	27	11-033/158/CC	28	12-000/158	35	12-013/336/ED	29
11-023/218/EX	27	11-033/158/CD	28	12-000/218	35	12-013/336/EJ	29
11-023/236/CA	27	11-033/158/CJ	28	12-000/236	35	12-013/358/CA	29
11-023/236/CB	27	11-033/158/CX	28	12-000/258	35	12-013/358/CD	29
11-023/236/CC	27	11-033/158/EA	28	12-003/118	35	12-013/358/CJ	29
11-023/236/CD	27	11-033/158/EB	28	12-003/218	35	12-013/358/EA	29
11-023/236/CJ	27	11-033/158/EC	28	12-013/118/CA	29	12-013/358/ED	29
11-023/236/CX	27	11-033/158/ED	28	12-013/118/CD	29	12-013/358/EJ	29
11-023/236/EA	27	11-033/158/EJ	28	12-013/118/CJ	29	12-013/418/CA	29
11-023/236/EB	27	11-033/158/EX	28	12-013/118/EA	29	12-013/418/CD	29
11-023/236/EC	27	11-033/218/CA	28	12-013/118/ED	29	12-013/418/CJ	29
11-023/236/ED	27	11-033/218/CB	28	12-013/118/EJ	29	12-013/418/EA	29
11-023/236/EJ	27	11-033/218/CC	28	12-013/136/CA	29	12-013/418/ED	29
11-023/236/EX	27	11-033/218/CD	28	12-013/136/CD	29	12-013/418/EJ	29
11-023/258/CA	27	11-033/218/CJ	28	12-013/136/CJ	29	12-013/436/CA	29
11-023/258/CB	27	11-033/218/CX	28	12-013/136/EA	29	12-013/436/CD	29
11-023/258/CC	27	11-033/218/EA	28	12-013/136/ED	29	12-013/436/CJ	29
11-023/258/CD	27	11-033/218/EB	28	12-013/136/EJ	29	12-013/436/EA	29
11-023/258/CJ	27	11-033/218/EC	28	12-013/158/CA	29	12-013/436/ED	29
11-023/258/CX	27	11-033/218/ED	28	12-013/158/CD	29	12-013/436/EJ	29
11-023/258/EA	27	11-033/218/EJ	28	12-013/158/CJ	29	12-013/458/CA	29
11-023/258/EB	27	11-033/218/EX	28	12-013/158/EA	29	12-013/458/CD	29
11-023/258/EC	27	11-033/236/CA	28	12-013/158/ED	29	12-013/458/CJ	29
11-023/258/ED	27	11-033/236/CB	28	12-013/158/EJ	29	12-013/458/EA	29
11-023/258/EJ	27	11-033/236/CC	28	12-013/218/CA	29	12-013/458/ED	29
11-023/258/EX	27	11-033/236/CD	28	12-013/218/CD	29	12-013/458/EJ	29
11-033/118/CA	28	11-033/236/CJ	28	12-013/218/CJ	29	12-023/118/CA	30
11-033/118/CB	28	11-033/236/CX	28	12-013/218/EA	29	12-023/118/CD	30
11-033/118/CC	28	11-033/236/EA	28	12-013/218/ED	29	12-023/118/CJ	30
11-033/118/CD	28	11-033/236/EB	28	12-013/218/EJ	29	12-023/118/EA	30
11-033/118/CJ	28	11-033/236/EC	28	12-013/236/CA	29	12-023/118/ED	30
11-033/118/CX	28	11-033/236/ED	28	12-013/236/CD	29	12-023/118/EJ	30
11-033/118/EA	28	11-033/236/EJ	28	12-013/236/CJ	29	12-023/136/CA	30
11-033/118/EB	28	11-033/236/EX	28	12-013/236/EA	29	12-023/136/CD	30
11-033/118/EC	28	11-033/258/CA	28	12-013/236/ED	29	12-023/136/CJ	30
11-033/118/ED	28	11-033/258/CB	28	12-013/236/EJ	29	12-023/136/EA	30
11-033/118/EJ	28	11-033/258/CC	28	12-013/258/CA	29	12-023/136/ED	30
11-033/118/EX	28	11-033/258/CD	28	12-013/258/CD	29	12-023/136/EJ	30
11-033/136/CA	28	11-033/258/CJ	28	12-013/258/CJ	29	12-023/158/CA	30
11-033/136/CB	28	11-033/258/CX	28	12-013/258/EA	29	12-023/158/CD	30
11-033/136/CC	28	11-033/258/EA	28	12-013/258/ED	29	12-023/158/CJ	30
11-033/136/CD	28	11-033/258/EB	28	12-013/258/EJ	29	12-023/158/EA	30
11-033/136/CJ	28	11-033/258/EC	28	12-013/318/CA	29	12-023/158/ED	30
11-033/136/CX	28	11-033/258/ED	28	12-013/318/CD	29	12-023/158/EJ	30
11-033/136/EA	28	11-033/258/EJ	28	12-013/318/CJ	29	12-023/218/CA	30
11-033/136/EB	28	11-033/258/EX	28	12-013/318/EA	29	12-023/218/CD	30
11-033/136/EC	28	11-100/118	35	12-013/318/ED	29	12-023/218/CJ	30
11-033/136/ED	28	11-100/218	35	12-013/318/EJ	29	12-023/218/EA	30
11-033/136/EJ	28	11-103/118	35	12-013/336/CA	29	12-023/218/ED	30

Index and Business terms & conditions

Code	page	Code	page	Code	page	Code	page
12-023/218/EJ	30	12-043/218/EA	29	12-100/218	35	13-013/414/CC	32
12-023/236/CA	30	12-043/218/ED	29	12-103/118	35	13-013/414/CD	32
12-023/236/CD	30	12-043/218/EJ	29	12-103/218	35	13-013/414/CJ	32
12-023/236/CJ	30	12-043/236/CA	29	13-013/114/CB	32	13-013/414/CX	32
12-023/236/EA	30	12-043/236/CD	29	13-013/114/CC	32	13-013/414/CZ	32
12-023/236/ED	30	12-043/236/CJ	29	13-013/114/CD	32	13-013/428/CB	32
12-023/236/EJ	30	12-043/236/EA	29	13-013/114/CJ	32	13-013/428/CC	32
12-023/258/CA	30	12-043/236/ED	29	13-013/114/CX	32	13-013/428/CD	32
12-023/258/CD	30	12-043/236/EJ	29	13-013/114/CZ	32	13-013/428/CJ	32
12-023/258/CJ	30	12-043/258/CA	29	13-013/128/CB	32	13-013/428/CX	32
12-023/258/EA	30	12-043/258/CD	29	13-013/128/CC	32	13-013/428/CZ	32
12-023/258/ED	30	12-043/258/CJ	29	13-013/128/CD	32	13-023/114/CB	33
12-023/258/EJ	30	12-043/258/EA	29	13-013/128/CJ	32	13-023/114/CC	33
12-033/118/CA	31	12-043/258/ED	29	13-013/128/CX	32	13-023/114/CD	33
12-033/118/CD	31	12-043/258/EJ	29	13-013/128/CZ	32	13-023/114/CJ	33
12-033/118/CJ	31	12-053/218/CA	30	13-013/135/CB	32	13-023/128/CB	33
12-033/118/EA	31	12-053/218/CD	30	13-013/135/CC	32	13-023/128/CC	33
12-033/118/ED	31	12-053/218/CJ	30	13-013/135/CD	32	13-023/128/CD	33
12-033/118/EJ	31	12-053/218/EA	30	13-013/135/CJ	32	13-023/128/CJ	33
12-033/136/CA	31	12-053/218/ED	30	13-013/135/CX	32	13-023/135/CB	33
12-033/136/CD	31	12-053/218/EJ	30	13-013/135/CZ	32	13-023/135/CC	33
12-033/136/CJ	31	12-053/236/CA	30	13-013/214/CB	32	13-023/135/CD	33
12-033/136/EA	31	12-053/236/CD	30	13-013/214/CC	32	13-023/135/CJ	33
12-033/136/ED	31	12-053/236/CJ	30	13-013/214/CD	32	13-023/214/CB	33
12-033/136/EJ	31	12-053/236/EA	30	13-013/214/CJ	32	13-023/214/CC	33
12-033/158/CA	31	12-053/236/ED	30	13-013/214/CX	32	13-023/214/CD	33
12-033/158/CD	31	12-053/236/EJ	30	13-013/214/CZ	32	13-023/214/CJ	33
12-033/158/CJ	31	12-053/258/CA	30	13-013/228/CB	32	13-023/228/CB	33
12-033/158/EA	31	12-053/258/CD	30	13-013/228/CC	32	13-023/228/CC	33
12-033/158/ED	31	12-053/258/CJ	30	13-013/228/CD	32	13-023/228/CD	33
12-033/158/EJ	31	12-053/258/EA	30	13-013/228/CJ	32	13-023/228/CJ	33
12-033/218/CA	31	12-053/258/ED	30	13-013/228/CX	32	13-023/235/CB	33
12-033/218/CD	31	12-053/258/EJ	30	13-013/228/CZ	32	13-023/235/CC	33
12-033/218/CJ	31	12-063/218/CA	31	13-013/235/CB	32	13-023/235/CD	33
12-033/218/EA	31	12-063/218/CD	31	13-013/235/CC	32	13-023/235/CJ	33
12-033/218/ED	31	12-063/218/CJ	31	13-013/235/CD	32	13-033/114/CB	34
12-033/218/EJ	31	12-063/218/EA	31	13-013/235/CJ	32	13-033/114/CC	34
12-033/236/CA	31	12-063/218/ED	31	13-013/235/CX	32	13-033/114/CD	34
12-033/236/CD	31	12-063/218/EJ	31	13-013/235/CZ	32	13-033/114/CJ	34
12-033/236/CJ	31	12-063/236/CA	31	13-013/314/CB	32	13-033/128/CB	34
12-033/236/EA	31	12-063/236/CD	31	13-013/314/CC	32	13-033/128/CC	34
12-033/236/ED	31	12-063/236/CJ	31	13-013/314/CD	32	13-033/128/CD	34
12-033/236/EJ	31	12-063/236/EA	31	13-013/314/CJ	32	13-033/128/CJ	34
12-033/258/CA	31	12-063/236/ED	31	13-013/314/CX	32	13-033/135/CB	34
12-033/258/CD	31	12-063/236/EJ	31	13-013/314/CZ	32	13-033/135/CC	34
12-033/258/CJ	31	12-063/258/CA	31	13-013/328/CB	32	13-033/135/CD	34
12-033/258/EA	31	12-063/258/CD	31	13-013/328/CC	32	13-033/135/CJ	34
12-033/258/ED	31	12-063/258/CJ	31	13-013/328/CD	32	13-033/214/CB	34
12-033/258/EJ	31	12-063/258/EA	31	13-013/328/CJ	32	13-033/214/CC	34
12-043/218/CA	29	12-063/258/ED	31	13-013/328/CX	32	13-033/214/CD	34
12-043/218/CD	29	12-063/258/EJ	31	13-013/328/CZ	32	13-033/214/CJ	34
12-043/218/CJ	29	12-100/118	35	13-013/414/CB	32	13-033/228/CB	34

Code	page	Code	page	Code	page	Code	page
13-033/228/CC	34	15-013/135/CC	36	15-033/136/EC	38	15-043/380/RC	39
13-033/228/CD	34	15-013/136/CB	36	15-033/158/CB	38	15-043/380/SB	39
13-033/228/CJ	34	15-013/136/CC	36	15-033/158/CC	38	15-043/380/SC	39
13-033/235/CB	34	15-013/136/EB	36	15-033/158/EB	38	15-043/380/TB	39
13-033/235/CC	34	15-013/136/EC	36	15-033/158/EC	38	15-043/380/TC	39
13-033/235/CD	34	15-013/158/CB	36	15-033/228/CB	38	15-053/228/CB	40
13-033/235/CJ	34	15-013/158/CC	36	15-033/228/CC	38	15-053/228/CC	40
13-043/214/CB	32	15-013/158/EB	36	15-033/235/CB	38	15-053/228/RB	40
13-043/214/CC	32	15-013/158/EC	36	15-033/235/CC	38	15-053/228/RC	40
13-043/214/CD	32	15-013/228/CB	36	15-033/236/CB	38	15-053/228/SB	40
13-043/214/CJ	32	15-013/228/CC	36	15-033/236/CC	38	15-053/228/SC	40
13-043/214/CX	32	15-013/235/CB	36	15-033/236/EB	38	15-053/228/TB	40
13-043/214/CZ	32	15-013/235/CC	36	15-033/236/EC	38	15-053/228/TC	40
13-043/228/CB	32	15-013/236/CB	36	15-033/236/EC	38	15-053/235/CB	40
13-043/228/CC	32	15-013/236/CC	36	15-033/258/CC	38	15-053/235/CC	40
13-043/228/CD	32	15-013/236/EB	36	15-033/258/EB	38	15-053/235/RB	40
13-043/228/CJ	32	15-013/236/EC	36	15-033/258/EC	38	15-053/235/RC	40
13-043/228/CX	32	15-013/258/CB	36	15-043/328/CB	39	15-053/235/SB	40
13-043/228/CZ	32	15-013/258/CC	36	15-043/328/CC	39	15-053/235/SC	40
13-043/235/CB	32	15-013/258/EB	36	15-043/328/RB	39	15-053/235/TB	40
13-043/235/CC	32	15-013/258/EC	36	15-043/328/RC	39	15-053/235/TC	40
13-043/235/CD	32	15-023/128/CB	37	15-043/328/SB	39	15-053/249/CB	40
13-043/235/CJ	32	15-023/128/CC	37	15-043/328/SC	39	15-053/249/CC	40
13-043/235/CX	32	15-023/135/CB	37	15-043/328/TB	39	15-053/249/RB	40
13-043/235/CZ	32	15-023/135/CC	37	15-043/328/TC	39	15-053/249/RC	40
13-053/214/CB	33	15-023/136/CB	37	15-043/335/CB	39	15-053/249/SB	40
13-053/214/CC	33	15-023/136/CC	37	15-043/335/CC	39	15-053/249/SC	40
13-053/214/CD	33	15-023/136/EB	37	15-043/335/RB	39	15-053/249/TB	40
13-053/214/CJ	33	15-023/136/EC	37	15-043/335/RC	39	15-053/249/TC	40
13-053/228/CB	33	15-023/158/CB	37	15-043/335/SB	39	15-053/254/CB	40
13-053/228/CC	33	15-023/158/CC	37	15-043/335/SC	39	15-053/254/CC	40
13-053/228/CD	33	15-023/158/EB	37	15-043/335/TB	39	15-053/254/RB	40
13-053/228/CJ	33	15-023/158/EC	37	15-043/335/TC	39	15-053/254/RC	40
13-053/235/CB	33	15-023/228/CB	37	15-043/349/CB	39	15-053/254/SB	40
13-053/235/CC	33	15-023/228/CC	37	15-043/349/CC	39	15-053/254/SC	40
13-053/235/CD	33	15-023/235/CB	37	15-043/349/RB	39	15-053/254/TB	40
13-053/235/CJ	33	15-023/235/CC	37	15-043/349/RC	39	15-053/254/TC	40
13-063/214/CB	34	15-023/236/CB	37	15-043/349/SB	39	17-013/236/C	41
13-063/214/CC	34	15-023/236/CC	37	15-043/349/SC	39	17-013/236/E	41
13-063/214/CD	34	15-023/236/EB	37	15-043/349/TB	39	17-013/258/C	41
13-063/214/CJ	34	15-023/236/EC	37	15-043/349/TC	39	17-013/258/E	41
13-063/228/CB	34	15-023/258/CB	37	15-043/354/CB	39	17-013/336/C	41
13-063/228/CC	34	15-023/258/CC	37	15-043/354/CC	39	17-013/336/E	41
13-063/228/CD	34	15-023/258/EB	37	15-043/354/RB	39	17-013/358/C	41
13-063/228/CJ	34	15-023/258/EC	37	15-043/354/RC	39	17-013/358/E	41
13-063/235/CB	34	15-033/128/CB	38	15-043/354/SB	39	17-013/436/C	41
13-063/235/CC	34	15-033/128/CC	38	15-043/354/SC	39	17-013/436/E	41
13-063/235/CD	34	15-033/135/CB	38	15-043/354/TB	39	17-013/458/C	41
13-063/235/CJ	34	15-033/135/CC	38	15-043/354/TC	39	17-013/458/E	41
15-013/128/CB	36	15-033/136/CB	38	15-043/380/CB	39	17-033/236/C	58
15-013/128/CC	36	15-033/136/CC	38	15-043/380/CC	39	17-033/236/E	58
15-013/135/CB	36	15-033/136/EB	38	15-043/380/RB	39	17-033/258/C	58

Index and Business terms & conditions

Code	page	Code	page	Code	page	Code	page
17-033/258/E	58	19-024/355/CZ	44	25-053/258/CT	117	30-023/136/EX	59
17-033/336/C	58	19-034/455/CZ	44	25-053/258/ET	117	30-023/136/EZ	59
17-033/336/E	58	19-034/655/CZ	44	25-073/118/CT	117	30-023/158/CA	59
17-033/358/C	58	21-013/118/CY	114	25-073/118/ET	117	30-023/158/CB	59
17-033/358/E	58	21-013/118/EY	114	25-073/136/CT	117	30-023/158/CC	59
17-033/436/C	58	21-013/136/CY	114	25-073/136/ET	117	30-023/158/CD	59
17-033/436/E	58	21-013/136/EY	114	25-073/158/CT	117	30-023/158/CJ	59
17-033/458/C	58	21-013/158/CY	114	25-073/158/ET	117	30-023/158/CX	59
17-033/458/E	58	21-013/158/EY	114	25-073/218/CT	117	30-023/158/CZ	59
18-013/118/C	42	21-013/218/CY	114	25-073/218/ET	117	30-023/158/EA	59
18-013/118/E	42	21-013/218/EY	114	25-073/236/CT	117	30-023/158/EB	59
18-013/136/C	42	21-013/236/CY	114	25-073/236/ET	117	30-023/158/EC	59
18-013/136/E	42	21-013/236/EY	114	25-073/258/CT	117	30-023/158/ED	59
18-013/158/C	42	21-013/258/CY	114	25-073/258/ET	117	30-023/158/EJ	59
18-013/158/E	42	21-013/258/EY	114	26-914/455/CT	118	30-023/158/EX	59
18-014/155/C	42	21-043/158/CYH	114	26-914/655/CT	118	30-023/158/EZ	59
18-014/236/C	42	21-043/158/EYH	114	26-924/455/CT	118	30-023/218/CA	59
18-014/236/E	42	21-043/180/CYH	114	26-934/455/CT	118	30-023/218/CB	59
18-014/255/C	42	21-043/218/CY	114	26-934/655/CT	118	30-023/218/CC	59
18-023/118/C	42	21-043/218/EY	114	26-944/455/CT	118	30-023/218/CD	59
18-023/118/E	42	21-043/236/CY	114	26-954/455/C	118	30-023/218/CJ	59
18-023/136/C	42	21-043/236/EY	114	26-954/655/C	118	30-023/218/CX	59
18-023/136/E	42	21-043/258/CY	114	26-964/455/C	118	30-023/218/CZ	59
18-023/158/C	42	21-043/258/EY	114	26-974/455/C	118	30-023/218/EA	59
18-023/158/E	42	23-013/118/C	116	26-974/655/C	118	30-023/218/EB	59
18-024/155/C	42	23-013/118/D	116	26-984/455/C	118	30-023/218/EC	59
18-024/236/C	42	23-013/118/E	116	30-023/118/CA	59	30-023/218/ED	59
18-024/236/E	42	23-013/136/C	116	30-023/118/CB	59	30-023/218/EJ	59
18-024/255/C	42	23-013/136/D	116	30-023/118/CC	59	30-023/218/EX	59
18-033/118/C	43	23-013/136/E	116	30-023/118/CD	59	30-023/218/EZ	59
18-033/118/E	43	23-013/158/C	116	30-023/118/CJ	59	30-023/236/CA	59
18-033/136/C	43	23-013/158/D	116	30-023/118/CX	59	30-023/236/CB	59
18-033/136/E	43	23-013/158/E	116	30-023/118/CZ	59	30-023/236/CC	59
18-033/158/C	43	23-013/218/C	116	30-023/118/EA	59	30-023/236/CD	59
18-033/158/E	43	23-013/218/D	116	30-023/118/EB	59	30-023/236/CJ	59
18-034/155/C	43	23-013/218/E	116	30-023/118/EC	59	30-023/236/CX	59
18-034/236/C	43	23-013/236/C	116	30-023/118/ED	59	30-023/236/CZ	59
18-034/236/E	43	23-013/236/D	116	30-023/118/EJ	59	30-023/236/EA	59
18-034/255/C	43	23-013/236/E	116	30-023/118/EX	59	30-023/236/EB	59
18-043/118/C	43	23-013/258/C	116	30-023/118/EZ	59	30-023/236/EC	59
18-043/118/E	43	23-013/258/D	116	30-023/136/CA	59	30-023/236/ED	59
18-043/136/C	43	23-013/258/E	116	30-023/136/CB	59	30-023/236/EJ	59
18-043/136/E	43	25-053/118/CT	117	30-023/136/CC	59	30-023/236/EX	59
18-043/158/C	43	25-053/118/ET	117	30-023/136/CD	59	30-023/236/EZ	59
18-043/158/E	43	25-053/136/CT	117	30-023/136/CJ	59	30-023/258/CA	59
18-044/155/C	43	25-053/136/ET	117	30-023/136/CX	59	30-023/258/CB	59
18-044/236/C	43	25-053/158/CT	117	30-023/136/CZ	59	30-023/258/CC	59
18-044/236/E	43	25-053/158/ET	117	30-023/136/EA	59	30-023/258/CD	59
18-044/255/C	43	25-053/218/CT	117	30-023/136/EB	59	30-023/258/CJ	59
19-014/255/CZ	44	25-053/218/ET	117	30-023/136/EC	59	30-023/258/CX	59
19-014/355/CZ	44	25-053/236/CT	117	30-023/136/ED	59	30-023/258/CZ	59
19-024/255/CZ	44	25-053/236/ET	117	30-023/136/EJ	59	30-023/258/EA	59

Code	page	Code	page	Code	page	Code	page
30-023/258/EB	59	30-023/436/CJ	59	30-033/158/EI	60	30-033/318/CZ	60
30-023/258/EC	59	30-023/436/CX	59	30-033/158/EJ	60	30-033/318/EA	60
30-023/258/ED	59	30-023/436/CZ	59	30-033/158/EX	60	30-033/318/EB	60
30-023/258/EJ	59	30-023/436/EA	59	30-033/158/EZ	60	30-033/318/EC	60
30-023/258/EX	59	30-023/436/EB	59	30-033/218/CA	60	30-033/318/ED	60
30-023/258/EZ	59	30-023/436/EC	59	30-033/218/CB	60	30-033/318/EJ	60
30-023/318/CA	59	30-023/436/ED	59	30-033/218/CC	60	30-033/318/EX	60
30-023/318/CB	59	30-023/436/EJ	59	30-033/218/CD	60	30-033/318/EZ	60
30-023/318/CC	59	30-023/436/EX	59	30-033/218/CJ	60	30-033/336/CA	60
30-023/318/CD	59	30-023/436/EZ	59	30-033/218/CX	60	30-033/336/CB	60
30-023/318/CJ	59	30-033/118/CA	60	30-033/218/CZ	60	30-033/336/CC	60
30-023/318/CX	59	30-033/118/CB	60	30-033/218/EA	60	30-033/336/CD	60
30-023/318/CZ	59	30-033/118/CC	60	30-033/218/EB	60	30-033/336/CJ	60
30-023/318/EA	59	30-033/118/CD	60	30-033/218/EC	60	30-033/336/CX	60
30-023/318/EB	59	30-033/118/CJ	60	30-033/218/ED	60	30-033/336/CZ	60
30-023/318/EC	59	30-033/118/CX	60	30-033/218/EJ	60	30-033/336/EA	60
30-023/318/ED	59	30-033/118/CZ	60	30-033/218/EX	60	30-033/336/EB	60
30-023/318/EJ	59	30-033/118/EA	60	30-033/218/EZ	60	30-033/336/EC	60
30-023/318/EX	59	30-033/118/EB	60	30-033/236/CA	60	30-033/336/ED	60
30-023/318/EZ	59	30-033/118/EC	60	30-033/236/CB	60	30-033/336/EJ	60
30-023/336/CA	59	30-033/118/ED	60	30-033/236/CC	60	30-033/336/EX	60
30-023/336/CB	59	30-033/118/EJ	60	30-033/236/CD	60	30-033/336/EZ	60
30-023/336/CC	59	30-033/118/EX	60	30-033/236/CJ	60	30-033/418/CA	60
30-023/336/CD	59	30-033/118/EZ	60	30-033/236/CX	60	30-033/418/CB	60
30-023/336/CJ	59	30-033/136/CA	60	30-033/236/CZ	60	30-033/418/CC	60
30-023/336/CX	59	30-033/136/CB	60	30-033/236/EA	60	30-033/418/CD	60
30-023/336/CZ	59	30-033/136/CC	60	30-033/236/EB	60	30-033/418/CJ	60
30-023/336/EA	59	30-033/136/CD	60	30-033/236/EC	60	30-033/418/CX	60
30-023/336/EB	59	30-033/136/CI	60	30-033/236/ED	60	30-033/418/CZ	60
30-023/336/EC	59	30-033/136/CJ	60	30-033/236/EJ	60	30-033/418/EA	60
30-023/336/ED	59	30-033/136/CX	60	30-033/236/EX	60	30-033/418/EB	60
30-023/336/EJ	59	30-033/136/CZ	60	30-033/236/EZ	60	30-033/418/EC	60
30-023/336/EX	59	30-033/136/EA	60	30-033/258/CA	60	30-033/418/ED	60
30-023/336/EZ	59	30-033/136/EB	60	30-033/258/CB	60	30-033/418/EJ	60
30-023/418/CA	59	30-033/136/EC	60	30-033/258/CC	60	30-033/418/EX	60
30-023/418/CB	59	30-033/136/ED	60	30-033/258/CD	60	30-033/418/EZ	60
30-023/418/CC	59	30-033/136/EI	60	30-033/258/CJ	60	30-033/436/CA	60
30-023/418/CD	59	30-033/136/EJ	60	30-033/258/CX	60	30-033/436/CB	60
30-023/418/CJ	59	30-033/136/EX	60	30-033/258/CZ	60	30-033/436/CC	60
30-023/418/CX	59	30-033/136/EZ	60	30-033/258/EA	60	30-033/436/CD	60
30-023/418/CZ	59	30-033/158/CA	60	30-033/258/EB	60	30-033/436/CJ	60
30-023/418/EA	59	30-033/158/CB	60	30-033/258/EC	60	30-033/436/CX	60
30-023/418/EB	59	30-033/158/CC	60	30-033/258/ED	60	30-033/436/CZ	60
30-023/418/EC	59	30-033/158/CD	60	30-033/258/EJ	60	30-033/436/EA	60
30-023/418/ED	59	30-033/158/CI	60	30-033/258/EX	60	30-033/436/EB	60
30-023/418/EJ	59	30-033/158/CJ	60	30-033/258/EZ	60	30-033/436/EC	60
30-023/418/EX	59	30-033/158/CX	60	30-033/318/CA	60	30-033/436/ED	60
30-023/418/EZ	59	30-033/158/CZ	60	30-033/318/CB	60	30-033/436/EJ	60
30-023/436/CA	59	30-033/158/EA	60	30-033/318/CC	60	30-033/436/EX	60
30-023/436/CB	59	30-033/158/EB	60	30-033/318/CD	60	30-033/436/EZ	60
30-023/436/CC	59	30-033/158/EC	60	30-033/318/CJ	60	30-053/418/CBL	61
30-023/436/CD	59	30-033/158/ED	60	30-033/318/CX	60	30-053/418/CDL	61

Index and Business terms & conditions

Code	page	Code	page	Code	page	Code	page
30-053/418/EBL	61	31-034/236/CD	63	32-023/228/CD	66	32-053/414/CD	67
30-053/418/EDL	61	31-034/236/CJ	63	32-023/228/CJ	66	32-053/414/CJ	67
30-093/418/CBL	61	31-034/236/CX	63	32-023/314/CB	66	32-053/428/CB	67
30-093/418/CDL	61	31-034/236/EB	63	32-023/314/CC	66	32-053/428/CC	67
30-093/418/EBL	61	31-034/236/EC	63	32-023/314/CD	66	32-053/428/CD	67
30-093/418/EDL	61	31-034/236/ED	63	32-023/314/CJ	66	32-053/428/CJ	67
30-653/418/CBL	61	31-034/236/EJ	63	32-023/328/CB	66	32-063/128/CB	67
30-653/418/CDL	61	31-034/236/EX	63	32-023/328/CC	66	32-063/128/CC	67
30-653/418/EBL	61	31-034/255/CB	63	32-023/328/CD	66	32-063/228/CB	67
30-653/418/EDL	61	31-034/255/CC	63	32-023/328/CJ	66	32-063/228/CC	67
31-024/236/CB	63	31-034/255/CD	63	32-023/414/CB	66	32-063/314/CB	67
31-024/236/CC	63	31-034/255/CJ	63	32-023/414/CC	66	32-063/314/CC	67
31-024/236/CD	63	31-034/255/CX	63	32-023/414/CD	66	32-063/414/CB	67
31-024/236/CJ	63	31-034/336/CB	63	32-023/414/CJ	66	32-063/414/CC	67
31-024/236/CX	63	31-034/336/CC	63	32-023/428/CB	66	32-073/128/CB	67
31-024/236/EB	63	31-034/336/CD	63	32-023/428/CC	66	32-073/128/CC	67
31-024/236/EC	63	31-034/336/CJ	63	32-023/428/CD	66	32-073/228/CB	67
31-024/236/ED	63	31-034/336/CX	63	32-023/428/CJ	66	32-073/228/CC	67
31-024/236/EJ	63	31-034/336/EB	63	32-033/214/CB	66	32-073/314/CB	67
31-024/236/EX	63	31-034/336/EC	63	32-033/214/CC	66	32-073/314/CC	67
31-024/255/CB	63	31-034/336/ED	63	32-033/214/CD	66	32-073/414/CB	67
31-024/255/CC	63	31-034/336/EJ	63	32-033/214/CJ	66	32-073/414/CC	67
31-024/255/CD	63	31-034/336/EX	63	32-033/228/CB	66	33-494/113/C	105
31-024/255/CJ	63	31-034/355/CB	63	32-033/228/CC	66	33-494/113/C++D	105
31-024/255/CX	63	31-034/355/CC	63	32-033/228/CD	66	33-494/113/D	105
31-024/336/CB	63	31-034/355/CD	63	32-033/228/CJ	66	33-494/113/D++D	105
31-024/336/CC	63	31-034/355/CJ	63	32-033/314/CB	66	33-494/113/E	105
31-024/336/CD	63	31-034/355/CX	63	32-033/314/CC	66	33-494/113/E++D	105
31-024/336/CJ	63	31-044/224/CB	64	32-033/314/CD	66	33-494/118/C	105
31-024/336/CX	63	31-044/224/CC	64	32-033/314/CJ	66	33-494/118/C++D	105
31-024/336/EB	63	31-044/236/CB	64	32-033/328/CB	66	33-494/118/D	105
31-024/336/EC	63	31-044/236/CC	64	32-033/328/CC	66	33-494/118/D++D	105
31-024/336/ED	63	31-044/236/CJ	64	32-033/328/CD	66	33-494/118/E	105
31-024/336/EJ	63	31-054/224/CB	64	32-033/328/CJ	66	33-494/118/E++D	105
31-024/336/EX	63	31-054/224/CC	64	32-033/414/CB	66	33-494/126/C	105
31-024/355/CB	63	31-054/236/CB	64	32-033/414/CC	66	33-494/126/C++D	105
31-024/355/CC	63	31-054/236/CC	64	32-033/414/CD	66	33-494/126/D	105
31-024/355/CD	63	31-054/236/CJ	64	32-033/414/CJ	66	33-494/126/D++D	105
31-024/355/CJ	63	31-064/236/CB	65	32-033/428/CB	66	33-494/126/E	105
31-024/355/CX	63	31-064/236/CD	65	32-033/428/CC	66	33-494/126/E++D	105
31-034/218/CB	63	31-064/236/EB	65	32-033/428/CD	66	33-494/132/C	105
31-034/218/CC	63	31-064/236/ED	65	32-033/428/CJ	66	33-494/132/C++D	105
31-034/218/CD	63	31-964/236/CB	65	32-043/414/CB	67	33-494/142/C	105
31-034/218/CJ	63	31-964/236/CD	65	32-043/414/CC	67	33-494/142/C++D	105
31-034/218/CX	63	31-964/236/EB	65	32-043/414/CD	67	33-494/213/C	105
31-034/218/EB	63	31-964/236/ED	65	32-043/414/CJ	67	33-494/213/C++D	105
31-034/218/EC	63	32-023/214/CB	66	32-043/428/CB	67	33-494/213/D	105
31-034/218/ED	63	32-023/214/CC	66	32-043/428/CC	67	33-494/213/D++D	105
31-034/218/EJ	63	32-023/214/CD	66	32-043/428/CD	67	33-494/213/E	105
31-034/218/EX	63	32-023/214/CJ	66	32-043/428/CJ	67	33-494/213/E++D	105
31-034/236/CB	63	32-023/228/CB	66	32-053/414/CB	67	33-494/218/C	105
31-034/236/CC	63	32-023/228/CC	66	32-053/414/CC	67	33-494/218/C++D	105

Code	page	Code	page	Code	page	Code	page
33-494/218/D	105	35-033/158/EX	73	36-064/336/EX	45	45-024/132/C	124
33-494/218/D++D	105	35-033/236/CX	73	36-064/355/CX	45	45-024/142/C	124
33-494/218/E	105	35-033/236/EX	73	36-073/236/CBT	46	45-024/157/C	124
33-494/218/E++D	105	35-033/258/CX	73	36-073/236/EBT	46	45-026/105/B	124
33-494/226/C	105	35-033/258/EX	73	36-073/258/CBT	46	45-026/110/B	124
33-494/226/C++D	105	35-033/418/CX	73	36-073/258/EBT	46	45-026/135/B	124
33-494/226/D	105	35-033/418/EX	73	36-074/236/CBT	46	45-027/107/B	124
33-494/226/D++D	105	35-034/336/CX	73	36-074/236/EBT	46	45-027/115/B	124
33-494/226/E	105	35-034/336/EX	73	36-074/255/CBT	46	45-027/135/B	124
33-494/226/E++D	105	35-034/355/CX	73	36-074/336/CBT	46	45-034/126/C	124
33-494/232/C	105	36-023/236/CX	74	36-074/336/EBT	46	45-034/126/E	124
33-494/232/C++D	105	36-023/236/EX	74	36-074/355/CBT	46	45-034/132/C	124
33-494/242/C	105	36-023/418/CX	74	37-012/120/+T	77	45-034/142/C	124
33-494/242/C++D	105	36-023/418/EX	74	37-014/118/CT	77	45-034/157/C	124
34-003/214/CA	68	36-024/336/CX	74	37-014/118/ET	77	45-036/105/B	124
34-003/214/CC	68	36-024/336/EX	74	37-014/126/CT	77	45-036/110/B	124
34-004/155/CA	68	36-024/355/CX	74	37-014/126/ET	77	45-036/135/B	124
34-004/155/CC	68	36-033/136/CX	75	37-017/107/BT	77	45-037/107/B	124
34-024/236/CC	69	36-033/136/EX	75	37-017/115/BT	77	45-037/115/B	124
34-024/236/EC	69	36-033/158/CX	75	40-011/115/+Y	119	45-037/135/B	124
34-024/255/CC	69	36-033/158/EX	75	43-056/125/BT	120	50-016/107/BY	128
34-034/155/CC	70	36-033/236/CX	75	43-056/140/BT	120	50-016/107/BZ	128
34-034/236/CC	70	36-033/236/EX	75	43-057/125/BT+1	120	50-016/110/BY	128
34-034/236/EC	70	36-033/258/CX	75	43-057/125/BT+2	120	50-016/110/BZ	128
34-034/255/CC	70	36-033/258/EX	75	43-057/140/BT+1	120	50-017/110/BY	128
34-044/236/CC	69	36-033/418/CX	75	43-057/140/BT+2	120	50-017/110/BZ	128
34-044/236/EC	69	36-033/418/EX	75	43-066/125/BT	120	50-017/115/BY	128
34-044/255/CC	69	36-034/336/CX	75	43-066/140/BT	120	50-017/115/BZ	128
34-054/155/CC	70	36-034/336/EX	75	43-067/125/BT+1	120	50-036/107/BY	128
34-054/236/CC	70	36-034/355/CX	75	43-067/125/BT+2	120	50-036/107/BZ	128
34-054/236/EC	70	36-043/236/CBT	76	43-067/140/BT+1	120	50-036/110/BY	128
34-054/255/CC	70	36-043/236/EBT	76	43-067/140/BT+2	120	50-036/110/BZ	128
34-063/214/CB	71	36-043/418/CBT	76	43-093/110/BT	121	50-037/110/BY	128
34-063/214/CC	71	36-043/418/EBT	76	43-093/115/BT	121	50-037/110/BZ	128
34-063/228/CB	71	36-044/336/CBT	76	45-005/125/B	122	50-037/115/BY	128
34-063/228/CC	71	36-044/336/EBT	76	45-005/140/B	122	50-037/115/BZ	128
34-064/155/CB	71	36-044/355/CBT	76	45-006/125/B	122	51-919/112/N	130
34-064/155/CC	71	36-053/236/CBT	76	45-006/140/B	122	51-919/222/N	130
34-093/214/CA	68	36-053/236/EBT	76	45-007/125/B++1	122	51-999/112/N	130
34-093/214/CC	68	36-053/418/CBT	76	45-007/125/B++2	122	51-999/222/N	130
34-094/155/CA	68	36-053/418/EBT	76	45-007/140/B++1	122	5611-261	134
34-094/155/CC	68	36-054/336/CBT	76	45-007/140/B++2	122	5611-270	135
35-023/236/CX	72	36-054/336/EBT	76	45-015/125/B	123	5611-280	136
35-023/236/EX	72	36-054/355/CBT	76	45-015/140/B	123	5611-292	134, 135
35-023/418/CX	72	36-063/236/CX	45	45-016/125/B	123	5611-293	134, 135
35-023/418/EX	72	36-063/236/EX	45	45-016/140/B	123	5611-296	136
35-024/336/CX	72	36-063/258/CX	45	45-017/125/B++1	123	66-051/106/+	82
35-024/336/EX	72	36-063/258/EX	45	45-017/125/B++2	123	66-051/106/++++0	82
35-024/355/CX	72	36-064/236/CX	45	45-017/140/B++1	123	66-051/106/++++C	82
35-033/136/CX	73	36-064/236/EX	45	45-017/140/B++2	123	66-051/106/++++M	82
35-033/136/EX	73	36-064/255/CX	45	45-024/126/C	124	66-051/106/++++N	82
35-033/158/CX	73	36-064/336/CX	45	45-024/126/E	124	66-051/110/+	82

Index and Business terms & conditions

Code	page	Code	page	Code	page	Code	page
66-051/110/++++0	82	66-451/110/+	82	72-949/571/NT	93	77-024/242/C	106
66-051/110/++++C	82	66-451/110/++++0	82	76-013/228/CZ	51	77-034/213/C	107
66-051/110/++++M	82	66-451/110/++++C	82	76-013/235/CZ	51	77-034/213/E	107
66-051/110/++++N	82	66-451/110/++++M	82	76-013/254/CZ	51	77-034/218/C	107
66-051/207/+	82	66-451/110/++++N	82	76-033/228/CZ	51	77-034/218/E	107
66-051/207/++++0	82	66-451/207/+	82	76-033/235/CZ	51	77-034/226/C	107
66-051/207/++++C	82	66-451/207/++++0	82	76-033/254/CZ	51	77-034/226/E	107
66-051/207/++++M	82	66-451/207/++++C	82	76-043/214/CZ	51	77-034/232/C	107
66-051/207/++++N	82	66-451/207/++++M	82	76-043/228/CZ	51	77-034/242/C	107
66-054/113/C	82	66-451/207/++++N	82	76-043/235/CZ	51	77-044/213/C	107
66-054/113/C+++0	82	66-454/213/C	82	76-043/254/CZ	51	77-044/213/E	107
66-054/113/C+++C	82	66-454/213/C+++0	82	76-043/414/CZ	51	77-044/218/C	107
66-054/113/C+++M	82	66-454/213/C+++C	82	76-043/424/CZ	51	77-044/218/E	107
66-054/113/C+++N	82	66-454/213/C+++M	82	76-053/114/CZ	52	77-044/226/C	107
66-054/113/D	82	66-454/213/C+++N	82	76-053/128/CZ	52	77-044/226/E	107
66-054/113/D+++0	82	66-454/226/C	82	76-053/135/CZ	52	77-044/232/C	107
66-054/113/D+++C	82	66-454/226/C+++0	82	76-053/154/CZ	52	77-044/242/C	107
66-054/113/D+++M	82	66-454/226/C+++C	82	76-053/214/CZ	52	77-054/213/C	107
66-054/113/D+++N	82	66-454/226/C+++M	82	76-053/228/CZ	52	77-054/213/E	107
66-054/213/C	82	66-454/226/C+++N	82	76-053/235/CZ	52	77-054/218/C	107
66-054/213/C+++0	82	67-004/214/C	50	76-053/254/CZ	52	77-054/218/E	107
66-054/213/C+++C	82	67-004/221/C	50	76-063/114/CZ	52	77-054/226/C	107
66-054/213/C+++M	82	67-004/224/C	50	76-063/128/CZ	52	77-054/226/E	107
66-054/213/C+++N	82	67-004/228/C	50	76-063/135/CZ	52	77-054/232/C	107
66-054/213/D	82	67-004/235/C	50	76-063/154/CZ	52	77-054/242/C	107
66-054/213/D+++0	82	67-004/239/C	50	76-063/214/CZ	52	78-002/107/N	94
66-054/213/D+++C	82	67-004/249/C	50	76-063/228/CZ	52	78-002/207/N	94
66-054/213/D+++M	82	67-004/254/C	50	76-063/235/CZ	52	78-002/307/N	94
66-054/213/D+++N	82	67-004/280/C	50	76-063/254/CZ	52	78-002/407/N	94
66-054/226/C	82	69-004/114/C	78	77-004/213/C	106	78-007/107/B	94
66-054/226/C+++0	82	69-004/121/C	78	77-004/213/E	106	78-007/107/C	94
66-054/226/C+++C	82	69-004/124/C	78	77-004/218/C	106	78-007/207/B	94
66-054/226/C+++M	82	69-004/128/C	78	77-004/218/E	106	78-007/207/C	94
66-054/226/C+++N	82	69-004/135/C	78	77-004/226/C	106	78-007/307/B	94
66-054/226/D	82	69-004/139/C	78	77-004/226/E	106	78-007/307/C	94
66-054/226/D+++0	82	69-004/149/C	78	77-004/232/C	106	78-007/407/B	94
66-054/226/D+++C	82	69-004/154/C	78	77-004/242/C	106	78-007/407/C	94
66-054/226/D+++M	82	69-004/180/C	78	77-014/213/C	106	78-012/105/N	95
66-054/226/D+++N	82	72-007/103/BT	90	77-014/213/E	106	78-012/107/N	95
66-071/206/+	83	72-007/103/CT	90	77-014/218/C	106	78-012/110/N	95
66-074/218/C	83	72-007/107/BT	90	77-014/218/E	106	78-012/205/N	95
66-074/218/D	83	72-007/107/CT	90	77-014/218/E	106	78-012/207/N	95
66-074/226/C	83	72-017/103/BT	91	77-014/226/C	106	78-012/210/N	95
66-074/226/D	83	72-017/103/CT	91	77-014/232/C	106	78-012/305/N	95
66-081/206/+	84	72-017/107/BT	91	77-014/242/C	106	78-012/307/N	95
66-081/206/++++R	84	72-017/107/CT	91	77-024/213/C	106	78-012/310/N	95
66-081/206/++++T	84	72-024/140/C	92	77-024/213/E	106	78-012/405/N	95
66-081/206/++++U	84	72-024/155/C	92	77-024/218/C	106	78-012/407/N	95
66-084/111/C	84	72-024/162/C	92	77-024/218/E	106	78-012/410/N	95
66-084/111/C+++R	84	72-034/140/C	92	77-024/226/C	106	78-022/405/N	95
66-084/111/C+++T	84	72-034/155/C	92	77-024/226/E	106	78-022/407/N	95
66-084/111/C+++U	84	72-034/162/C	92	77-024/232/C	106	78-022/410/N	95

Code	page	Code	page	Code	page
81-033/154/CB	47	82-014/126/EZ	99	82-044/118/C++D	102
81-033/154/CC	47	82-014/213/CZ	99	82-044/118/E	102
81-033/180/CB	47	82-014/213/EZ	99	82-044/118/E++D	102
81-033/180/CC	47	82-014/218/CZ	99	82-044/126/C	102
81-033/249/CB	47	82-014/218/EZ	99	82-044/126/C++D	102
81-033/249/CC	47	82-014/226/CZ	99	82-044/126/E	102
81-033/254/CB	47	82-014/226/EZ	99	82-044/126/E++D	102
81-033/254/CC	47	82-024/113/C	100	82-044/132/C	102
81-033/280/CB	47	82-024/113/C++D	100	82-044/132/C++D	102
81-033/280/CC	47	82-024/113/E	100	82-044/142/C	102
81-919/403/N	48	82-024/113/E++D	100	82-044/142/C++D	102
82-004/113/C	98	82-024/118/C	100	82-044/218/C	102
82-004/113/C++D	98	82-024/118/C++D	100	82-044/218/C++D	102
82-004/113/C++H	98	82-024/118/E	100	82-044/218/E	102
82-004/113/E	98	82-024/118/E++D	100	82-044/218/E++D	102
82-004/113/E++D	98	82-024/126/C	100	82-044/226/C	102
82-004/113/E++H	98	82-024/126/C++D	100	82-044/226/C++D	102
82-004/118/C	98	82-024/126/E	100	82-044/226/E	102
82-004/118/C++D	98	82-024/126/E++D	100	82-044/226/E++D	102
82-004/118/C++H	98	82-024/213/C	100	82-044/232/C	102
82-004/118/E	98	82-024/213/C++D	100	82-044/232/C++D	102
82-004/118/E++D	98	82-024/213/E	100	82-044/242/C	102
82-004/118/E++H	98	82-024/213/E++D	100	82-044/242/C++D	102
82-004/126/C	98	82-024/218/C	100	82-959/113/NSP	104
82-004/126/C++D	98	82-024/218/C++D	100	82-969/113/NSP	104
82-004/126/C++H	98	82-024/218/E	100	82-979/113/NSP	104
82-004/126/E	98	82-024/218/E++D	100	82-989/113/NSP	104
82-004/126/E++D	98	82-034/118/C	101	89-003/114/CX	49
82-004/126/E++H	98	82-034/118/C++D	101	89-003/114/CZ	49
82-004/213/C	98	82-034/118/E	101	89-003/124/CX	49
82-004/213/C++D	98	82-034/118/E++D	101	89-003/124/CZ	49
82-004/213/C++H	98	82-034/126/C	101	89-003/128/CX	49
82-004/213/E	98	82-034/126/C++D	101	89-003/128/CZ	49
82-004/213/E++D	98	82-034/126/E	101	89-003/135/CX	49
82-004/213/E++H	98	82-034/126/E++D	101	89-003/135/CZ	49
82-004/218/C	98	82-034/132/C	101	89-003/139/CX	49
82-004/218/C++D	98	82-034/132/C++D	101	89-003/139/CZ	49
82-004/218/C++H	98	82-034/142/C	101	89-003/149/CX	49
82-004/218/E	98	82-034/142/C++D	101	89-003/149/CZ	49
82-004/218/E++D	98	82-034/218/C	101	89-003/154/CX	49
82-004/218/E++H	98	82-034/218/C++D	101	89-003/154/CZ	49
82-004/226/C	98	82-034/218/E	101	89-003/180/CX	49
82-004/226/C++D	98	82-034/218/E++D	101	89-003/180/CZ	49
82-004/226/C++H	98	82-034/226/C	101		
82-004/226/E	98	82-034/226/C++D	101		
82-004/226/E++D	98	82-034/226/E	101		
82-004/226/E++H	98	82-034/226/E++D	101		
82-014/113/CZ	99	82-034/232/C	101		
82-014/113/EZ	99	82-034/232/C++D	101		
82-014/118/CZ	99	82-034/242/C	101		
82-014/118/EZ	99	82-034/242/C++D	101		
82-014/126/CZ	99	82-044/118/C	102		

Index and Business terms & conditions

Code	page	Code	page	Code	page	Code	page
99-047/040	12, 13	99-094/040	22, 23, 24, 26, 27, 28, 29, 30, 31, 32, 33, 34	99-212	129	99-363	35
99-047/060	12, 13			99-213	129	99-365	35
99-048/040	12, 13	99-094/060	22, 23, 24, 26, 27, 28, 29, 30, 31, 32, 33, 34	99-214	129	99-366	35
99-048/060	12, 13			99-215	129	99-371	35
99-049/040	12, 13	99-094/090	22, 23, 24, 26, 27, 28, 29, 30, 31, 32, 33, 34	99-216	129	99-372	35
99-049/060	12, 13			99-258/500	122, 123	99-373	35
99-077/060	13	99-094/120	22, 23, 24, 26, 27, 28, 29, 30, 31, 32, 33, 34	99-2500	117	99-375	35
99-078/060	13			99-25C1	117	99-376	35
99-079/060	13	99-095/040	24, 26, 27, 28, 29, 30, 31, 32, 33, 34	99-264/28	18	99-421	35
99-080/120	22, 23, 24, 27, 28, 29, 30, 31, 32, 33, 34, 36, 37, 38			99-264/35	18	99-431	35
99-081/120	22, 23, 24, 27, 28, 29, 30, 31, 32, 33, 34, 36, 37, 38	99-095/060	24, 26, 27, 28, 29, 30, 31, 32, 33, 34	99-264/36	18	99-461	35
99-082/120	24, 27, 28, 29, 30, 31, 32, 33, 34, 36, 37, 38			99-264/58	18	99-462	35
99-083/120	22, 23, 24, 26, 27, 28, 29, 30, 31, 32, 33, 34	99-095/090	24, 26, 27, 28, 29, 30, 31, 32, 33, 34	99-265/28	18	99-463	35
99-084/120	22, 23, 24, 26, 27, 28, 29, 30, 31, 32, 33, 34			99-265/35	18	99-471	35
99-085/120	24, 26, 27, 28, 29, 30, 31, 32, 33, 34	99-095/120	24, 26, 27, 28, 29, 30, 31, 32, 33, 34	99-265/36	18	99-472	35
99-087/120	14, 15, 16			99-265/58	18	99-473	35
99-088/120	14, 15, 16	99-096/120	18, 19, 20	99-267/28	18	99-490	15
99-089/120	14, 15, 16	99-103	27, 28	99-267/35	18	99-491	15
99-090/040	22, 23, 24, 27, 28, 29, 30, 31, 32, 33, 34	99-104	26, 27, 28	99-267/36	18	99-492	15
99-090/060	22, 23, 24, 27, 28, 29, 30, 31, 32, 33, 34	99-107	30, 31, 33, 34	99-267/58	18	99-493	15
99-090/090	22, 23, 24, 27, 28, 29, 30, 31, 32, 33, 34	99-108	30, 31, 33, 34	99-275	12, 13	99-494	15
99-090/120	22, 23, 24, 27, 28, 29, 30, 31, 32, 33, 34	99-129	130	99-276	12, 13	99-541	114, 115
99-091/040	22, 23, 24, 27, 28, 29, 30, 31, 32, 33, 34	99-130	15, 16	99-277	12, 13	99-542	114, 115
99-091/060	22, 23, 24, 27, 28, 29, 30, 31, 32, 33, 34	99-131	15, 16	99-281/118	117	99-543	114, 115
99-091/090	22, 23, 24, 27, 28, 29, 30, 31, 32, 33, 34	99-135	12	99-281/136	117	99-544	114, 115
99-091/120	22, 23, 24, 27, 28, 29, 30, 31, 32, 33, 34	99-136	13	99-281/158	117	99-545	114, 115
99-092/040	24, 27, 28, 29, 30, 31, 32, 33, 34	99-180	114	99-281/218	117	99-546	114, 115
99-092/060	24, 27, 28, 29, 30, 31, 32, 33, 34	99-181	114	99-281/236	117	99-547	114, 115
99-092/090	24, 27, 28, 29, 30, 31, 32, 33, 34	99-182	114	99-281/258	117	99-551	12
99-092/120	24, 27, 28, 29, 30, 31, 32, 33, 34	99-183	114	99-282/118	117	99-552	12
99-093/040	22, 23, 24, 26, 27, 28, 29, 30, 31, 32, 33, 34	99-184	114	99-282/136	117	99-553	12
99-093/060	22, 23, 24, 26, 27, 28, 29, 30, 31, 32, 33, 34	99-185	114	99-282/158	117	99-554	12
99-093/090	22, 23, 24, 26, 27, 28, 29, 30, 31, 32, 33, 34	99-186	114	99-282/218	117	99-555	12
99-093/120	22, 23, 24, 26, 27, 28, 29, 30, 31, 32, 33, 34	99-187	114	99-282/236	117	99-556	12
		99-188	114	99-282/258	117	99-558/350	124
		99-189	114	99-291	65	99-558/500	122, 123
		99-190	114	99-292	65	99-568/320	124
		99-191	114	99-294	60	99-568/420	124
		99-193	116	99-298	58, 60, 63, 66, 67, 68, 69, 70	99-569/520	122, 123
		99-194	116	99-299	58, 60, 63, 66, 67, 68, 69, 70	99-576/320	124
		99-195	116	99-321	35	99-576/420	124
		99-201	129	99-322	35	99-577/320	124
		99-202	129	99-323	35	99-577/420	124
		99-203	129	99-325	35	99-578/320	124
		99-204	129	99-326	35	99-578/350	124
		99-205	129	99-331	35	99-578/420	124
		99-206	129	99-332	35	99-578/500	122, 123
		99-207	129	99-333	35	99-578/520	122, 123
		99-208	129	99-335	35	99-580	116
		99-209	129	99-336	35	99-581	116
		99-210	129	99-361	35	99-582	116
		99-211	129	99-362	35	99-583	116

Code	page	Code	page	Code	page	Code	page
99-584	116	99-915	103	GSLED-WHT-WHT45-MFL-ACH-AB-IG	86	GSSLED-WHT-WHT65-NSP-ACH-AC-CNP	85
99-588/320	124	99-920	51	GSLED-WHT-WHT45-MFL-ACH-AC-IG	86	GSSLED-WHT-WHT65-NSP-ACH-AC-CNP	85
99-588/420	124	99-972	47, 48	GSLED-WHT-WHT45-NSP-ACH-AB-IG	86	GSSLED-WHT-WHT65-NSP-ACH-AC-STK	85
99-590/520	122, 123	99-973	47	GSLED-WHT-WHT45-NSP-ACH-AC-IG	86	GSSLED-WHT-WHT65-NSP-ACH-AC-STK	85
99-695	118	99-974	47	GSLED-WHT-WHT65-MFL-ACH-AB-IG	86	SPYLED-3-WHT-WHT32-MFL-AC-AB-AC60-WL	87
99-825	120	99-975	47	GSLED-WHT-WHT65-MFL-ACH-AC-IG	86	SPYLED-3-WHT-WHT32-MFL-AC-AB-SM-WL	87
99-826	120	99-976	47	GSLED-WHT-WHT65-NSP-ACH-AB-IG	86	SPYLED-3-WHT-WHT32-MFL-AC-AC-AC60-WL	87
99-827	120			GSLED-WHT-WHT65-NSP-ACH-AC-IG	86	SPYLED-3-WHT-WHT32-MFL-AC-AC-SM-WL	87
99-830	98			GSSLED-WHT-WHT32-MFL-ACH-AB-CNP	85	SPYLED-3-WHT-WHT32-NSP-AC-AB-AC60-WL	87
99-831	98			GSSLED-WHT-WHT32-MFL-ACH-AB-CNP	85	SPYLED-3-WHT-WHT32-NSP-AC-AB-SM-WL	87
99-832	98			GSSLED-WHT-WHT32-MFL-ACH-AB-STK	85	SPYLED-3-WHT-WHT32-NSP-AC-AC-AC60-WL	87
99-833	100			GSSLED-WHT-WHT32-MFL-ACH-AB-STK	85	SPYLED-3-WHT-WHT32-NSP-AC-AC-SM-WL	87
99-834	101			GSSLED-WHT-WHT32-MFL-ACH-AC-CNP	85	SPYLED-3-WHT-WHT45-MFL-AC-AB-AC60-WL	87
99-835	101			GSSLED-WHT-WHT32-MFL-ACH-AC-CNP	85	SPYLED-3-WHT-WHT45-MFL-AC-AB-SM-WL	87
99-836	102			GSSLED-WHT-WHT32-MFL-ACH-AC-STK	85	SPYLED-3-WHT-WHT45-MFL-AC-AC-AC60-WL	87
99-837	102			GSSLED-WHT-WHT32-MFL-ACH-AC-STK	85	SPYLED-3-WHT-WHT45-MFL-AC-AC-SM-WL	87
99-839	100			GSSLED-WHT-WHT32-NSP-ACH-AB-CNP	85	SPYLED-3-WHT-WHT45-NSP-AC-AB-AC60-WL	87
99-840	103			GSSLED-WHT-WHT32-NSP-ACH-AB-CNP	85	SPYLED-3-WHT-WHT45-NSP-AC-AB-SM-WL	87
99-841	103			GSSLED-WHT-WHT32-NSP-ACH-AB-STK	85	SPYLED-3-WHT-WHT45-NSP-AC-AC-AC60-WL	87
99-842	103			GSSLED-WHT-WHT32-NSP-ACH-AB-STK	85	SPYLED-3-WHT-WHT45-NSP-AC-AC-SM-WL	87
99-844	103			GSSLED-WHT-WHT32-NSP-ACH-AC-CNP	85	SPYLED-3-WHT-WHT65-MFL-AC-AB-AC60-WL	87
99-845	103			GSSLED-WHT-WHT32-NSP-ACH-AC-CNP	85	SPYLED-3-WHT-WHT65-MFL-AC-AC-AC60-WL	87
99-850	49, 50			GSSLED-WHT-WHT32-NSP-ACH-AC-STK	85	SPYLED-3-WHT-WHT65-MFL-AC-AC-SM-WL	87
99-851	49			GSSLED-WHT-WHT32-NSP-ACH-AC-STK	85	SPYLED-3-WHT-WHT65-NSP-AC-AB-AC60-WL	87
99-852	49			GSSLED-WHT-WHT45-MFL-ACH-AB-CNP	85	SPYLED-3-WHT-WHT65-NSP-AC-AB-SM-WL	87
99-853	49			GSSLED-WHT-WHT45-MFL-ACH-AB-CNP	85	SPYLED-3-WHT-WHT65-NSP-AC-AC-AC60-WL	87
99-877	105			GSSLED-WHT-WHT45-MFL-ACH-AB-STK	85	SPYLED-3-WHT-WHT65-NSP-AC-AC-SM-WL	87
99-878	105			GSSLED-WHT-WHT45-MFL-ACH-AB-STK	85	SPYLED-4-WHT-WHT32-MFL-AC-AB-AC60-WL	87
99-879	105			GSSLED-WHT-WHT45-MFL-ACH-AC-CNP	85	SPYLED-4-WHT-WHT32-MFL-AC-AB-SM-WL	87
99-880	105			GSSLED-WHT-WHT45-MFL-ACH-AC-CNP	85	SPYLED-4-WHT-WHT32-MFL-AC-AC-AC60-WL	87
99-881	105	BS710-WHT-WHT32-MFL-ACH-12ACT-AC60	88	GSSLED-WHT-WHT45-MFL-ACH-AC-STK	85	SPYLED-4-WHT-WHT32-MFL-AC-AC-SM-WL	87
99-892	103	BS710-WHT-WHT32-MFL-ACH-12ACT-PK24	88	GSSLED-WHT-WHT45-MFL-ACH-AC-STK	85	SPYLED-4-WHT-WHT32-NSP-AC-AB-AC60-WL	87
99-893	103	BS710-WHT-WHT32-MFL-ACH-12ACT-PK36	88	GSSLED-WHT-WHT45-NSP-ACH-AB-CNP	85	SPYLED-4-WHT-WHT32-NSP-AC-AB-SM-WL	87
99-894	103	BS710-WHT-WHT32-NSP-ACH-12ACT-AC60	88	GSSLED-WHT-WHT45-NSP-ACH-AB-CNP	85	SPYLED-4-WHT-WHT32-NSP-AC-AC-AC60-WL	87
99-895	103	BS710-WHT-WHT32-NSP-ACH-12ACT-PK24	88	GSSLED-WHT-WHT45-NSP-ACH-AB-STK	85	SPYLED-4-WHT-WHT32-NSP-AC-AC-SM-WL	87
99-896	103	BS710-WHT-WHT32-NSP-ACH-12ACT-PK36	88	GSSLED-WHT-WHT45-NSP-ACH-AB-STK	85	SPYLED-4-WHT-WHT45-MFL-AC-AB-AC60-WL	87
99-897	103	BS710-WHT-WHT45-MFL-ACH-12ACT-AC60	88	GSSLED-WHT-WHT45-NSP-ACH-AC-CNP	85	SPYLED-4-WHT-WHT45-MFL-AC-AB-SM-WL	87
99-898	103	BS710-WHT-WHT45-MFL-ACH-12ACT-PK24	88	GSSLED-WHT-WHT45-NSP-ACH-AC-CNP	85	SPYLED-4-WHT-WHT45-MFL-AC-AC-AC60-WL	87
99-899	103	BS710-WHT-WHT45-MFL-ACH-12ACT-PK36	88	GSSLED-WHT-WHT45-NSP-ACH-AC-STK	85	SPYLED-4-WHT-WHT45-MFL-AC-AC-SM-WL	87
99-900	103	BS710-WHT-WHT45-NSP-ACH-12ACT-AC60	88	GSSLED-WHT-WHT45-NSP-ACH-AC-STK	85	SPYLED-4-WHT-WHT45-NSP-AC-AB-AC60-WL	87
99-902	103	BS710-WHT-WHT45-NSP-ACH-12ACT-PK24	88	GSSLED-WHT-WHT65-MFL-ACH-AB-CNP	85	SPYLED-4-WHT-WHT45-NSP-AC-AB-SM-WL	87
99-903	103	BS710-WHT-WHT45-NSP-ACH-12ACT-PK36	88	GSSLED-WHT-WHT65-MFL-ACH-AB-CNP	85	SPYLED-4-WHT-WHT45-NSP-AC-AC-AC60-WL	87
99-904	103	BS710-WHT-WHT65-MFL-ACH-12ACT-AC60	88	GSSLED-WHT-WHT65-MFL-ACH-AB-STK	85	SPYLED-4-WHT-WHT45-NSP-AC-AC-SM-WL	87
99-905	103	BS710-WHT-WHT65-MFL-ACH-12ACT-PK24	88	GSSLED-WHT-WHT65-MFL-ACH-AB-STK	85	SPYLED-4-WHT-WHT65-MFL-AC-AB-AC60-WL	87
99-906	103	BS710-WHT-WHT65-MFL-ACH-12ACT-PK36	88	GSSLED-WHT-WHT65-MFL-ACH-AC-CNP	85	SPYLED-4-WHT-WHT65-MFL-AC-AB-SM-WL	87
99-908	103	BS710-WHT-WHT65-NSP-ACH-12ACT-AC60	88	GSSLED-WHT-WHT65-MFL-ACH-AC-CNP	85	SPYLED-4-WHT-WHT65-MFL-AC-AC-AC60-WL	87
99-909	103	BS710-WHT-WHT65-NSP-ACH-12ACT-PK24	88	GSSLED-WHT-WHT65-MFL-ACH-AC-CNP	85	SPYLED-4-WHT-WHT65-MFL-AC-AB-SM-WL	87
99-910	103	BS710-WHT-WHT65-NSP-ACH-12ACT-PK36	88	GSSLED-WHT-WHT65-MFL-ACH-AC-STK	85	SPYLED-4-WHT-WHT65-MFL-AC-AC-SM-WL	87
99-911	103	GSLED-WHT-WHT32-MFL-ACH-AB-IG	86	GSSLED-WHT-WHT65-MFL-ACH-AC-STK	85	SPYLED-4-WHT-WHT65-NSP-AC-AB-AC60-WL	87
99-912	103	GSLED-WHT-WHT32-MFL-ACH-AC-IG	86	GSSLED-WHT-WHT65-NSP-ACH-AB-CNP	85	SPYLED-4-WHT-WHT65-NSP-AC-AB-SM-WL	87
99-913	103	GSLED-WHT-WHT32-NSP-ACH-AB-IG	86	GSSLED-WHT-WHT65-NSP-ACH-AB-CNP	85	SPYLED-4-WHT-WHT65-NSP-AC-AC-AC60-WL	87
99-914	103	GSLED-WHT-WHT32-NSP-ACH-AC-IG	86	GSSLED-WHT-WHT65-NSP-ACH-AB-STK	85	SPYLED-4-WHT-WHT65-NSP-AC-AC-SM-WL	87

I. General Provisions

These General Terms and Conditions of Sale (hereinafter »Terms«) govern relations between BEGHELLI - ELPLAST, a.s. (hereinafter »Beghelli-Elplast«), as the seller, and its customers (hereinafter »Buyer«), in selling / purchasing of products, goods, and services provided by Beghelli-Elplast (hereinafter »Products«).

II. Sequence of Documents

In case of a divergence between provisions of various documents regulating relations between Beghelli-Elplast and the Buyer, in the sense and in the extent in which they are in contradiction, the sequence of their obligatory force is as follows:

1. Single-purpose conditions agreed upon individually for a specific business transaction and confirmed in writing by both parties in a relevant commercial document (inquiry, offer, order, order acknowledgement, invoice).
2. Contract of purchase or a general contract of purchase, if such is entered into between Beghelli-Elplast and the Buyer.
3. Special commercial terms and conditions, which are part of the contract of purchase or the general contracts of purchase between Beghelli-Elplast and the Buyer.
4. These Terms.

III. Ordering Procedure

The Buyer submits its purchase orders in writing via electronic mail or by fax. The order shall include, among others, unambiguous specification and quantity of Products and the required delivery term. By its receipt by Beghelli-Elplast the purchase order becomes binding.

Unless expressly agreed between Beghelli-Elplast and the Buyer in writing in documents specified in the Article II. Par. 1 of these Terms, any part of the Buyer's purchase order which is in contradiction or anyway inconsistent with these Terms, will be ignored and not applied to the concerned business transaction.

Beghelli-Elplast shall acknowledge the purchase order in writing via electronic mail or by fax, specifying the delivery time or the currently available quantity. In case Beghelli-Elplast cannot confirm the delivery time of some or all items of the order within 48 (forty eight) hours, it shall confirm to the Buyer at least the fact of the order receipt including information on the supposed term of sending the final order acknowledgment.

In no event shall Beghelli-Elplast be liable for consequences of an eventually denied order or of any part of it.

If within 7 (seven) calendar days after receipt of the order acknowledgement by the Buyer, or within a shorter term in respect of the supposed delivery term, the Buyer does not raise in writing via electronic mail or by fax any objection against the supposed delivery time or against other terms of the order acknowledgement, the order acknowledgement becomes the only binding and final document superior to the Buyer's order. Any changes of the order so acknowledged are possible only in very exceptional cases and only after a prior written agreement of Beghelli-Elplast by cancellation of the concerned item in the original order and issuance of a new one.

In case meeting of a delivery time confirmed in the order acknowledgement appears unfeasible, Beghelli-Elplast shall inform the Buyer not later than 1 (one) day prior the supposed delivery term and indicate a substitutive delivery time.

In no event shall Beghelli-Elplast be liable for loss of profit, operational loss, specific, subsequent, incidental or criminal damages or damages of any other kind due to its failure to meet the delivery times confirmed in an order acknowledgement.

IV. Delivery / Takeover of Products

Unless stipulated otherwise in the documents specified in the Article II. Par. 1 of these Terms, the delivery terms are EXW Brno (place of the distribution warehouse or production plant of Beghelli-Elplast). Transfer of the costs and risks from Beghelli-Elplast to the Buyer is governed by the corresponding provisions of Incoterms 2000.

Upon takeover of the Products, at the moment and at the location pursuant to the applied delivery terms, the Buyer is obliged to examine conformity of the Products or cause them to be examined in respect of their specification, quantity, completeness, and external damage.

If within 7 (seven) calendar days from the date of the takeover the Buyer does not raise any claim of nonconformity, using the appropriate procedure on the Beghelli-Elplast's website, via electronic mail, or by fax, the risk of a lack of quantity, incompleteness or external damage of the Products passes to the Buyer – except when the proper examination cannot be done without unpacking of the single Product. In such case the period for raising a claim for Products nonconformity is extended until the proper examination can be first done, however not longer than for 14 (fourteen) calendar days from the Products takeover.

V. Payment

The Buyer shall pay for the supplied Products within the period, in the currency and on the bank account indicated in the Beghelli-Elplast's invoice. The due day is the day when the Beghelli-Elplast's account is credited.

Should the Buyer is in delay with the payment, Beghelli-Elplast may require a delay interest of 0,1% on the unpaid amount for each day of the delay. Paying off such delay interests by the Buyer does not affect Beghelli-Elplast's right to indemnity for eventual other damages related to the delayed payment.

In case the Buyer's delay with payment becomes substantial, Beghelli-Elplast has the right to suspend or cancel all remaining orders of the Buyer and require an immediate payment for all its issued invoices regardless of their maturity. Such measure does not affect Beghelli-Elplast's right to indemnity for eventual other damages related to the delayed payment.

VI. Reserve of Property Right

The property right to the Products passes over to the Buyer not until it pays to Beghelli-Elplast the purchase price in the full amount. In case of a payment delay, Beghelli-Elplast may prohibit the Buyer from using the delivered Products or may apply its right to the Products return. For the whole such time, the Buyer is responsible for all risks relating to the delivered Products.

Until the property right passes over from Beghelli-Elplast to the Buyer, the Buyer cannot transfer it to any third person. In case of breach of this property reserve by the Buyer in consequence of which a third party would attain in good faith the property right to the Products, Beghelli-Elplast would become entitled to a contractual penalty amounting up to the price of the so concerned Products, which the Buyer is obliged to pay within by Beghelli-Elplast requested time. Paying off such a penalty by the Buyer does not affect Beghelli-Elplast's right to indemnity for eventual other related damages.

Further sale of the Products, to which the Beghelli-Elplast's reserve of property applies, to a third party is possible only on the condition that the Buyer reserves its right of property for at least the period until it fully pays to Beghelli-Elplast for the concerned Products.

On the reserved Products no lien may be imposed nor may the Products be used by anybody as a security for any kind of liability.

Eventual return of the Products as a consequence of its failure to pay does not deprive the Buyer of its obligation to pay for the Products which were not returned, to compensate the derogated value of the Products that were not returned in the quality in which they had been supplied, or to pay off the whole delay interest to which Beghelli-Elplast is entitled.

VII. Price and Terms Modification

Prices or other terms and conditions stated in Beghelli-Elplast's general pricelists, promotional or other commercial materials have an informative character only and in no way constitute the Buyer's right to obtain them.

The prices in Beghelli-Elplast's pricelists exclude VAT, recycling fee and other charges, taxes or duties of any kind, which, in case they are applicable to the Products according to the local law and Beghelli-Elplast is obliged to pay them, will be re-invoiced to the Buyer separately from the selling price.

In the event of unforeseen sudden changes of material, energy or other sub-supply prices, other costs and circumstances which Beghelli-Elplast cannot influence nor put off, Beghelli-Elplast reserves the right to modify prices, payment, delivery and other terms and conditions with an immediate effect. Such modified prices or terms and conditions shall be applicable to all Products previously ordered by the Buyer and acknowledged by Beghelli-Elplast upon receipt of a written Beghelli-Elplast's notice by the Buyer via electronic mail or by fax. In such case the Buyer has the right to withdraw from all so affected and so far not delivered orders or from their parts.

VIII. Changes of Products

Beghelli-Elplast reserves the right at its own discretion to change or modify technical specification of the Products or to alter the range of the Products by withdrawing or changing of the existing Products or adding new ones, provided such change does not substantially affect functional properties in a negative way, dimensions or service life of the concerned Products.

IX. Warranty

With exceptions pursuant to Article VII. of these Terms, Beghelli-Elplast guarantees that the Products shall be of identical type and properties referred to in its technical documentation and free of defects in material and workmanship for a period of – if not stated otherwise in the accompanying documents of the particular Products or in other Beghelli-Elplast documentation – 24 (twenty four) months from the day of the Beghelli-Elplast's invoice to the Buyer (hereinafter »Warranty Period«). After expiry of such Warranty Period, the Buyer may not enforce its right to indemnity for any damage due to such nonconformities.

In case a nonconformity of the supplied Products occurs during the Warranty Period, the Buyer is obliged to inform Beghelli-Elplast using the appropriate procedure on Beghelli-Elplast's website or via electronic mail or by fax, not later than within 3 (three) working days from discovery of this fact and to provide Beghelli-Elplast with information and collaboration it may require, including obtaining samples of the Products under the claim and dispatching them to Beghelli-Elplast headquarters.

In case Beghelli-Elplast acknowledges justification of the claim, it provides the Buyer with a remedy in the form and in the sequence as stated below:

- defective Product repair or replacement of its defective parts;
- replacement of the defective Product with a defect-free one;
- compensation of the purchase price.

The decision on form of the remedy is in Beghelli-Elplast's sole discretion dependent on the technical, logistic, and other circumstances. Beghelli-Elplast may also grant to the Buyer a reasonable discount on the price, if the Buyer agrees.

Without a prior written consent of Beghelli-Elplast, the Buyer may neither dispatch the Products under the claim to Beghelli-Elplast, nor delay, nor fully or partially suspend payment for the concerned Products.

This warranty does not cover any faults caused by normal deterioration; accelerated deterioration caused by specific physical, chemical or electrochemical conditions; insufficient maintenance or incorrect repair; failure to observe storage, user and operating instructions; use of unsuitable materials, parts and tools; as well as any fault due to circumstances beyond Beghelli-Elplast reasonable control.

There are no other warranties, expressed or implied, direct or indirect, beyond those expressly set forth herein. In no event shall Beghelli-Elplast be liable for loss of profit, operational loss, specific, subsequent, incidental or criminal damages or damages of any other kind based on a nonconformity claim or otherwise related to the Products supplied by Beghelli-Elplast pursuant to these Terms or to particular business transactions complying with these Terms.

No claim of any kind, where as to Products delivered or for failure to deliver, and whether or not based on negligence, shall be greater in amount than the selling price of the Products with respect to which such claim is made.

The Buyer shall not provide any guarantee, expressed or implied, direct or indirect, relating to any Product, which would differ from the warranties provided by Beghelli-Elplast for such Product.

X. Force Majeure

Beghelli-Elplast shall not be liable for a partial or entire failure to meet its obligations pursuant to these Terms, especially for suspension, delay or cancellation of the Buyer's orders, even if previously acknowledged, in cases beyond its reasonable control, including but without limitation:

- intervention of force majeure, war, revolt, civil riots, embargo, interference of civil or military authorities;
- changes relating to administrative, hygienic, and medical laws or regulations;
- strikes, operational or other production disruptions;
- interruption of or hindrance in transport;
- fire, floods, other climate extremes and natural hazard events;

In such events the Buyer has no right to indemnity for any damages, penalties, nor any other indemnification, direct or indirect.

Similar events entitle the Buyer not to take the ordered Products, even already manufactured; however none of these entitles the Buyer not to fulfill its liabilities related to the Products delivered previously, especially to pay the purchase price at the full amount and in the agreed term.

In case of impossibility to meet their obligations for such reasons, Beghelli-Elplast or the Buyer are obliged to advise without unnecessary delay the other party of this fact and its reasons, as well as of ceasing of their effects once it comes on.

XI. Governing Law – Jurisdiction

Relations not expressly regulated by these Terms, nor by other documents as specified in the Article II. Par. 1 of these Terms, are governed by United Nations Convention on contracts for the international sale of goods, Vienna, 1980/04/11.

All disputes arisen between Beghelli-Elplast and the Buyer in connection to these Terms which could not be settled by their mutual conciliation shall be submitted to a sole arbitrator. The arbitrator shall be appointed by the Chairman of Committee of International Arbitration of the National Committee of International Chamber of Commerce of the Czech Republic.

Note:

These General Terms and Conditions of Sale are regularly updated and in this catalogue they are for information only. Binding and up to date General Terms and Conditions of Sale will be sent to you together with Sales Documentation or Contract or if need be on request.

BEGHELLI - ELPLAST, a.s.

Poříčí 3A, 603 16 Brno - Czech Republic
tel.: +420 531 014 111, fax: +420 531 014 210
e-mail: beghelli@beghelli.cz, www.beghelli.cz

